

The Wireless Constructor

6^D
MONTHLY

EDITED BY
PERCY W. HARRIS

CONTENTS.

Vol. I. No. 1. NOVEMBER, 1924.

- HOW TO MAKE:
 - A LONG-RANGE CRYSTAL SET.
 - A UNIQUE SINGLE-VALVE RECEIVER.
 - A THREE-VALVE NEUTRODYNE RECEIVER.

All by Percy W. Harris.

HOW TO MAKE THE RESISTOFLEX TWO-VALVE RECEIVER.

By John Scott-Taggart, F.Inst.P., A.M.I.E.E.

HOW TO SOLDER.

HOW TO READ A CIRCUIT DIAGRAM.

By E. Redpath.

HOW TO MAKE YOUR OWN COILS.

By G. P. Kendall, B.Sc.

Hundreds of Practical Hints and Tips for the Beginner.

1/6 Blueprint
FREE inside.



№1. OF GREAT NEW MONTHLY

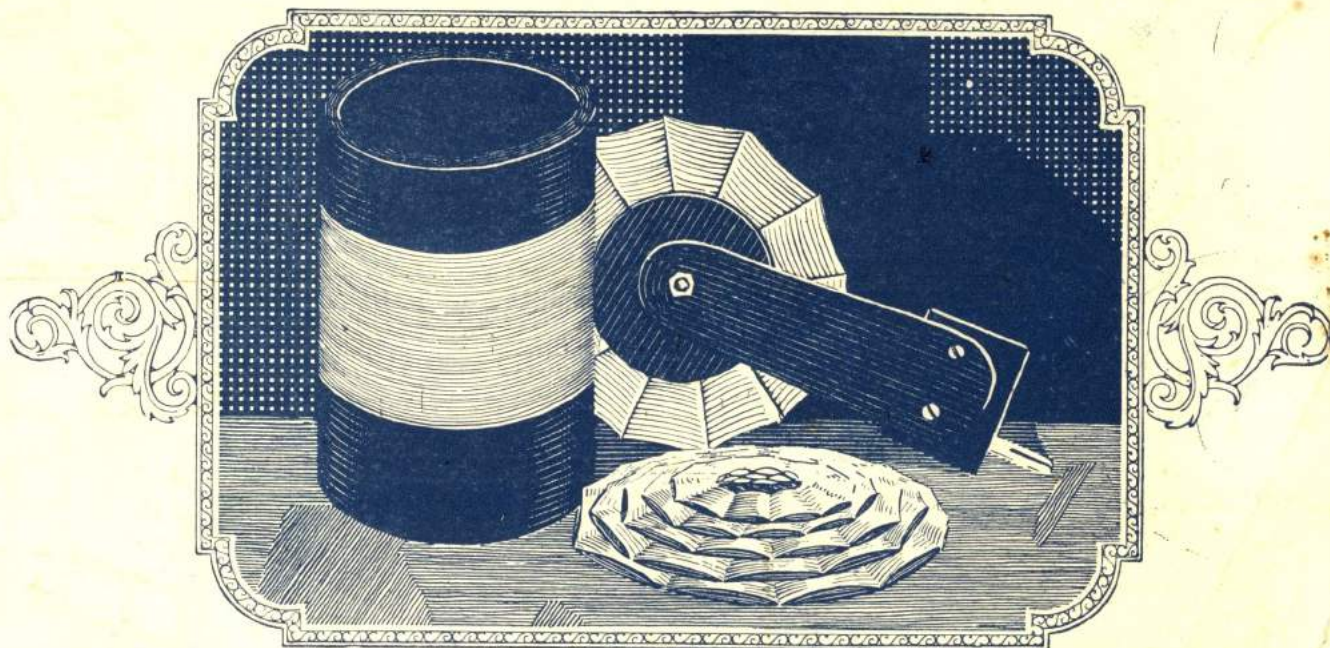

Tuning Coils and How to Wind Them.

By G.P. Kendall, B.Sc.

CONTENTS

- How Circuits are tuned
- Turn numbers
- The choice of wire
- Taking tappings
- Damp proofing
- Single layer coils
- Basket coils
- Slab coils
- Pile winding
- Lattice coils
- Honeycomb and duo-lateral coils
- Mounting coils
- Aperiodic Aerial coils

1/6

Series No. 18

Post free 1/8

—time spent in winding good Coils is never wasted

AS the Author says, "Many of the coils used are directly responsible for the mediocre results obtained by some experimenters."

Yes, that is the whole point. Because the Set works in a more or less unsatisfactory manner, yet apparently all is in order, the experimenter blames either his locality, his aerial or even the transmitting station. And the whole trouble often lies in his inefficient tuning arrangements.

Sharp tuning cannot be obtained with inefficient coils. Once you have learnt how to make good ones from this new Book you'll be sorry to think that you have wasted so much time with your earlier inefficient ones.

Buy a copy to-day—a surprisingly large amount of accurate information is yours at barely the cost of half-a-dozen terminals.

RADIO PRESS, LTD. - Devereux Court, Strand - W.C.2

IF IT IS A RADIO PRESS BOOK IT IS TECHNICALLY CORRECT

The
WIRELESS CONSTRUCTOR

— Edited by Percy W. Harris —

VOL. I. No. 1.NOVEMBER,

CONTENTS

Editorial 3	A Picture Guide to Basket Coil Winding 48
The Crusoe Crystal and Valve Set 4	The Radio Bug Gets a Bite ... 53
How to Solder 8	How to Fit a Valve into a Holder 57
Aerial Warfare in Our Suburb ... 11	Some Interesting Questions Answered 58
The Resistoflex Receiver 12	Easily-made Plug-in Coils for 5 XX 59
Six Popular Circuits in Pictures ... 17	Switches in Wireless Circuits ... 60
A 3-Valve Loose-Coupled Neutrodyne Receiver 19	For the Absolute Beginner ... 67
How to Read a Wireless Circuit Diagram 38	Some Common Faults in Beginners' Sets 71
Radio Press News 42	

READ THE OCTOBER NUMBER OF "MODERN WIRELESS"

1/- NET. Edited by JOHN SCOTT-TAGGART, F.Inst.P., A.M.I.E.E. **NOW ON SALE.**
Published by Radio Press Ltd., the proprietors of "Wireless Weekly," and "The Wireless Constructor."

OCTOBER CONTENTS:

A Three-Valve Receiver with Resistance Coupled Note Magnifier.
BY HERBERT K. SIMPSON.

In Passing.
The Resistoflex Circuit.
BY JOHN SCOTT-TAGGART, F.Inst.P., A.M.I.E.E.

A Romance of Fleet Street.
A Loose-Coupled Single Valve Reaction Receiver.
BY STANLEY G. RATTEE, Member I.R.E.

"The Wireless Constructor."
Regular Programmes from Continental Broadcasting Stations.
BY CAPTAIN L. F. PLUGGE, B.Sc., F.R.A.S., F.R.Met.S.

A Tapped-Coil Crystal Set.
BY WALTER STEVENS.

Above and Below the Broadcast Wavelengths. Multi-Stage High-Frequency Amplification.
BY JOHN SCOTT-TAGGART, F.Inst.P., A.M.I.E.E.

Early "Wireless" History.
BY H. J. HINKS, F.R.A., M.I.E.E.

Readers' Experiences.
Notes on the Transatlantic Receivers.
BY PERCY W. HARRIS.

Some Efficient Single Valve Reflex Circuits.
BY JOHN SCOTT-TAGGART, F.Inst.P., A.M.I.E.E.

Service Department Notes.
Trouble Corner.
Tested by Ourselves.

and many other articles.

NEXT MONTH : The leading article will deal with :

"A New Multi-stage High-frequency Amplifying System."
By John Scott-Taggart, F.Inst.P., A.M.I.E.E.

Some of the Constructional articles :

"The Transatlantic 4-valve Receiver."
A new set by Percy W. Harris.
"A Self-Contained Single Valve Set."
By Herbert K. Simpson.

A Five-Guinea Loud Speaker Receiver!

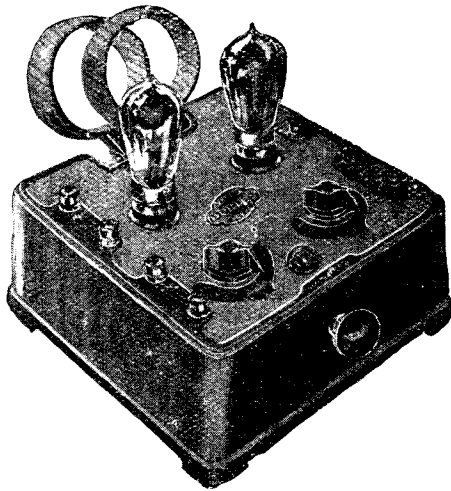

The Ethophone-Duplex is built in a one-piece matt-surfaced case moulded of an insulating compound having the appearance and properties of ebonite.

The Ethophone-Duplex

THE Ethophone-Duplex is intended expressly for listeners who want an efficient loud speaker receiver at moderate cost. Reception of broadcast about 20 miles from a normal power station and about 100 miles from the high power station on a loud speaker may be expected under favourable conditions. The range on head telephones may be four or five times as great. Dull-emitter or bright valves may be used without alteration to the set. The first valve acts as a radio frequency amplifier as well as a detector. Tuning is effected by two controls and the wave-length range extends from 250 metres upwards.

The low price of the Ethophone-Duplex is due to mass production methods. The instrument is fully up to the usual high standard of Burndept Apparatus. At five guineas you will not get a better receiver. Write for full particulars.

No. 1503. Ethophone Duplex, without valves, batteries, coils, etc., with full instructions, £5 5 0. To which must be added, £1 5 0 Marconi Licence.

The Anti-Phonic Valve Holder

John Scott - Taggart, F.Inst.P., A.M.I.E.E., writes in the "Wireless Weekly," dated Sept. 10: "I consider this new component as an example of enterprise which is curiously lacking in the industry to-day."

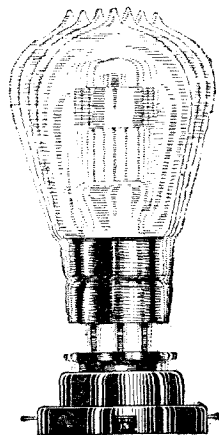

This illustration shows what happens when you tap the valve. Ordinarily, four springs in the base of the Anti-Phonic Holder absorb mechanical shocks, so protecting the filament of the valve.

WHATEVER valves you use, the Anti-Phonic Valve holder will tend to preserve their life by relieving the filament from all shocks. Read this extract from a lecture delivered at the Institute of Electrical Engineers:—

"Very numerous experiments in connection with the microphonic noise characteristic of dull-emitter valves have driven us to the conclusion that the effect is entirely due to the filament retaining a high degree of elasticity at its normal operating temperature. At present the only practicable method of eliminating these noises seems to be to mount the valve on a special type of holder designed to prevent any except very low frequency vibrations from reaching the valve."

The Anti-Phonic Valve Holder prevents vibrations of a frequency of eight per second—too low to be heard. No rubber is used.

No. 401. Anti-Phonic Valve Holder. Diameter 2 3/8 ins., height just over 1 in. For panel or base mounting. In carton with screws, 6/-.

Purchase Burndept by its name—substitutes are not the same.

DISPLAYS of our new apparatus are being held at all our Provincial Branches and by our Principal Agents.



BURNDEPT LTD., Aldine House, Bedford St., Strand, W.C.2.

LEEDS : Basinghall Street (near City Square).

CARDIFF : 67, Queen Street. NORTHAMPTON : 8, The Drapery.

Scientific Adviser:
Prof. G. W. O. HOWE,
D.Sc., M.I.E.E.

Advisory Editors:
Prof. R. WHIDDINGTON
M.A., D.Sc.
Prof. C. L. FORTESCUE,
M.A., M.I.E.E.

The WIRELESS CONSTRUCTOR

Staff Editors:
E. H. CHAPMAN, M.A.
D.Sc.
A. D. COWPER, M.Sc.
R. W. HALLOWS, M.A.
G. P. KENDALL, B.Sc.
S. G. RATTEE,
Member I.R.E.

Vol. I.

NOVEMBER, 1924.

No. 1.

OUR NEW MAGAZINE

AS Editor-in-Chief of all Radio Press publications, I have great pleasure in introducing No. 1 of THE WIRELESS CONSTRUCTOR to 175,000 readers. This figure alone will give the clue to our reasons for adding to the already very great number of readers who support the Radio Press. THE WIRELESS CONSTRUCTOR is frankly out for a very large circulation by producing a magazine having special features which will appeal to a very wide public, and by pricing the periodical at the extremely moderate sum of sixpence, which, in these days, even the humblest schoolboy can afford.

Wireless Weekly, at sixpence, appeals to a certain class of the wireless public, while *Modern Wireless* also has its special appeal.

The lines on which THE WIRELESS CONSTRUCTOR will be planned are different from those of either of these papers, and there will consequently be no clashing between the three magazines issued by Radio Press, Limited, a concern which devotes itself exclusively to the publication of wireless literature, and consequently is capable of being equipped and organised for the production of reliable publications.

By becoming a reader of one or more of the Radio Press publications you will derive benefit which no other concern can give. Only by the production of several

journals and many books can an organisation like our own give such unrivalled service and facilities. A very highly qualified technical staff, a service department which no others can boast

facilities to every class of wireless enthusiast. Every issue of THE WIRELESS CONSTRUCTOR will be of great interest and value to every beginner, although some of the articles will appeal to the more advanced constructor.

There is no need to introduce Mr. Percy W. Harris, who has been appointed Editor of this new paper. His reputation as a wireless designer is unrivalled, and his knowledge of what the constructor needs is such that a paper of this kind could not be placed in more capable hands.

We ask you to tell your friends who are beginners about this new magazine. We also ask you to use the order form which is enclosed in every issue of this journal when replying to advertisers. A guarantee is printed on the form, and the use of this will ensure you receiving prompt attention and, in the case of any trouble, which is extremely unlikely, the backing of the largest firm of wireless publishers in the world is behind you. Provided you use our order form, you will obtain the fullest satisfaction, and you can feel the same confidence that all members of the wireless public feel in

the articles and publications of the Radio Press.



Mr. Percy W. Harris.

and which will put a set right for an extremely small sum, provided you are a reader of Radio Press publications, and many other advantages are at your disposal.

We are now able to give all these

John Scott-Taggart

Editor-in-Chief of Radio Press, Ltd.



The Crusoe Crystal and Valve Set

By PERCY W. HARRIS, Editor.

Robinson Crusoe could have made this set from odd bits saved from the wreck!

THIS is the story of a simple wireless set I made up to amuse a friend who wanted to see just how simple a crystal set could be. Do not despise this set because of its humble appearance—it will work just as well as an expensive crystal set, and better than many. You can make it in an evening, and in building it you will

mine from the outside covering of a box of breakfast food), leaving the tinfoil exposed at the two portions indicated. At the rear of the baseboard stands a coil which you must wind in the way to be described. A short length of No. 16 wire is brought round, bent into a loop, and screwed down tightly to the tinfoil with a wood screw and a washer.



You tune this set with your finger!

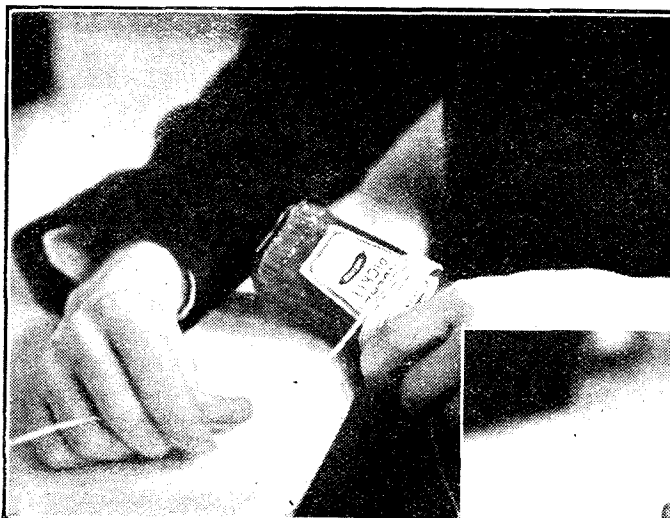

Winding the thick wire coil.

learn a great deal about wireless which otherwise would take a long time to learn from a book.

Raw Material.

The material required will be found about the house for the most part, and all you will need to buy is a pound of No. 16 D.C.C. wire, a sixpenny piece of crystal, and, of course, the inevitable pair of telephones (if you cannot borrow these from a neighbour). If you wish to hear Chelmsford as well you will need, in addition, about $\frac{1}{4}$ lb. of No. 24 double cotton-covered wire. Let us look at the set and see just how simple it is. We have first of all a baseboard which can be made from any piece of dry wood, measuring as shown in the drawing. On the front of this baseboard you must gum a piece of tinfoil such as is used in wrapping cigarettes, using a piece of the dimensions given. On top of this you must stick down a piece of waxed paper (I obtained

the baseboard another piece of No. 16 wire, bared of its insulation, is secured, one end having been twisted round a pencil so as to form a crystal cup, the other end being allowed to stick in the air. Into this crystal cup is forced a large piece of tinfoil, in which the crystal itself is imbedded, save for

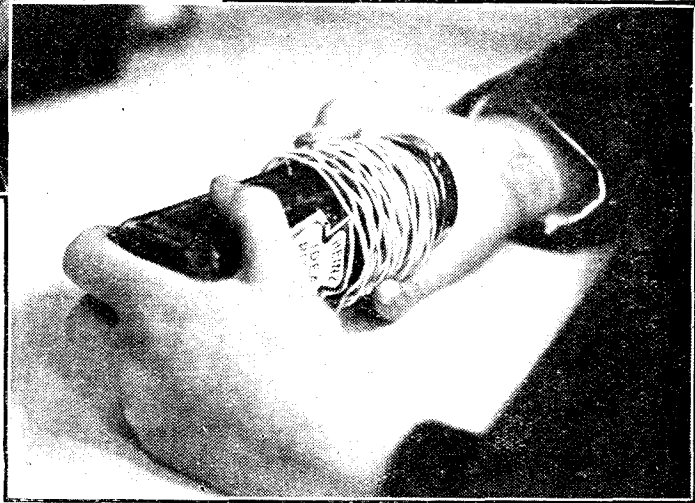

Removing the coil by twisting.

By means of another wood screw and a piece of No. 16 wire, bared, of course, of its cotton insulation, and twisted as shown in the diagram you must now make the first of the telephone terminals. Notice that one end of this wire makes contact with the tinfoil on the base. Just to the right of this another piece of wire is held down to the baseboard, one end terminating in a small coil as before, the other being bent up in the form of a support for the "cat-whisker." Further back on

its upper surface. The piece of tinfoil makes quite sufficient contact.

The cat-whisker must be made from the thinnest piece of wire you have about the house. After twisting it round a pencil, remove the insulation from each end, slipping one end of this wire cat-whisker in the coil of the cat-whisker holder, the other end being allowed to rest gently on the crystal. You will also need to cut a piece of wood $2\frac{3}{4}$ in. by $1\frac{1}{2}$ in. On one side of this you must gum a piece of tinfoil

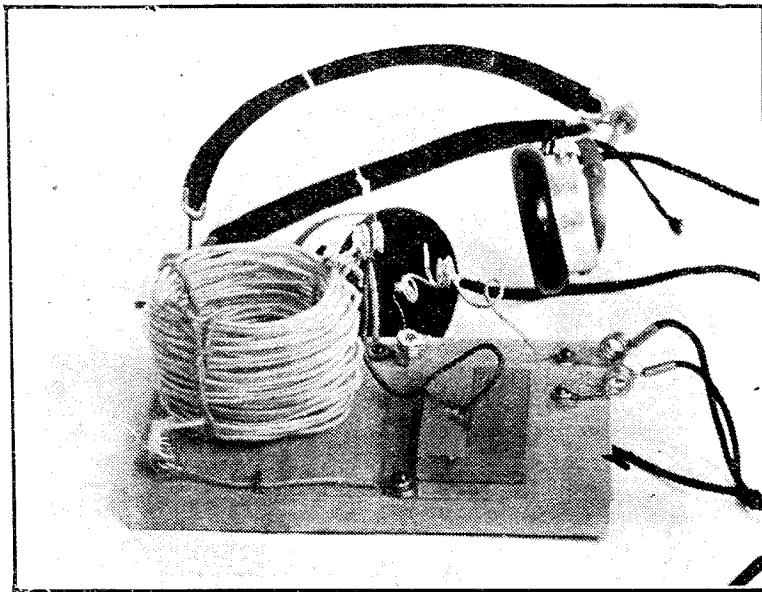

The Crusoe Crystal Set ready for work.

which is also stuck round one end and halfway across the top. A wood screw and washer hold against the upper side of the tinfoil one end of a piece of wire, which can be a single piece of the rubber-covered electric lighting flex so easily obtainable. The other end of this flexible wire can be secured by twisting tightly to the piece of wire which stands vertically and has for its lower end the crystal cup.

Winding the Coil

The next step is to wind the coil. For this you will need a hexagonal pickle bottle. The hexagonal shape is deliberately chosen for the purpose you will discover later. Take one end of your No. 16 D.C.C. wire and hold it under the thumb of the left hand. Now with the right hand wind a coil of 50 turns tightly on to the bottle. If you find that you cannot get the whole of the 50 turns on to the bottle then release the end which is being held by your thumb and let the coil spring off a little way, pushing the remaining turns along to take the place of those turns which have been released. Now carry on until you have wound 50 turns, cut off the wire after leaving about 6 in. to spare, and release the coil from the bottle with a slight twist. Pick up the loose coil and assemble it by bringing all the turns together. You will now find that the kinks in the wire do not come immediately above one another, but the kink of one layer comes above a straight portion in the layer below. This staggering of the turns enables the coil to be pressed together without

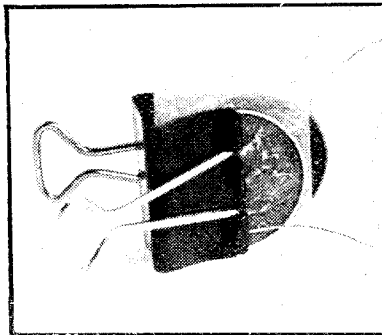

The simply-made grid condenser.

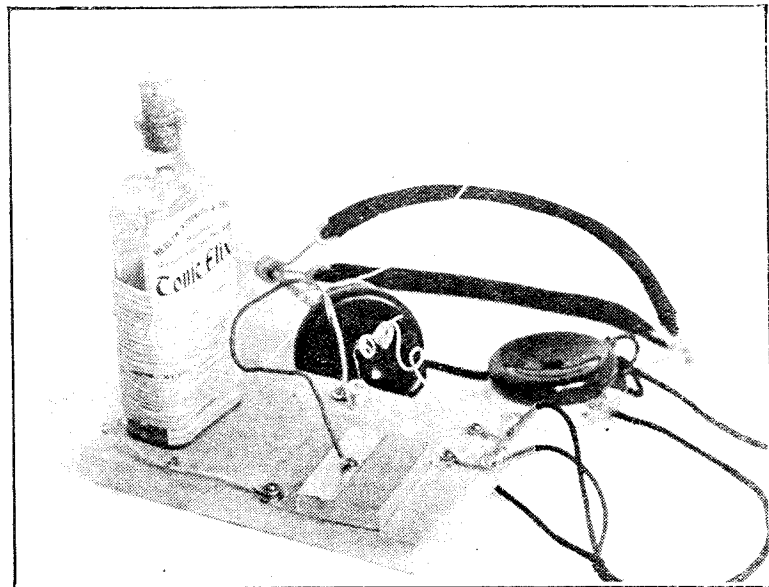

The Chelmsford coil in place. This is made by winding about 150 turns of No. 24 cotton-covered wire in two layers on a medicine bottle. It is joined up in the same way as the smaller coil.

collapsing, and when you have pressed it in the form shown in the photograph, tie it with string or thread. Now twist each end into a small spiral and bend the spirals into the correct position, so that one coil clips on the wire on the baseboard and the other will allow itself to be pushed on to the upright wire from the crystal cup. Your components are now complete.

Connecting Up

The set is now ready to connect up. This is a very simple matter. Bring your aerial wire to the upper end of the aerial coil, where it is connected to the upright wire from the crystal cup. Take the earth wire to the lower end of the coil, where it is connected to the wire on the baseboard. The telephones should be connected to the front two spirals, the leads being pushed into the clips as shown. Lay the cat-whisker very gently on some point on the crystal and listen for signals. If you do not hear them, try tuning the set by sliding the piece of wood with its tinfoil covering over the surface of the waxed paper so as to cover a greater or smaller area of the tinfoil. With the coil shown, on an ordinary aerial, you will find that you can tune from about 300 to 430 metres. If you live near a broadcasting station with a wavelength longer than 400 metres, I would suggest to you that you increase the number of turns of the coil from 50 to 70. A trifling adjustment of the cat-whisker and a little more tuning will soon bring in the signals at good strength.

Of course, if you care to spend a shilling or two you can substitute for the crystal cup and the wire cat-whisker, a proper holder and the set will be all the easier to operate.

Although it is so simple, this set works quite well on an indoor aerial about six miles from a broadcasting station, and on a reasonable outdoor aerial will give excellent signals at about 20 miles or even more.

The Valve Set

Having completed our "Crusoe" crystal set and heard good signals, the next step was to see how simply we could make a valve set. For the tuner portion the crystal tuner served, it being merely necessary to remove the cat-whisker from the crystal and to connect the wires in a certain way.

"Well, anyway, you will have to buy a grid condenser and a 2 megohm leak," said my friend. "You can't very well improvise these!"

In this he was wrong, for with the aid of a paper clip, three

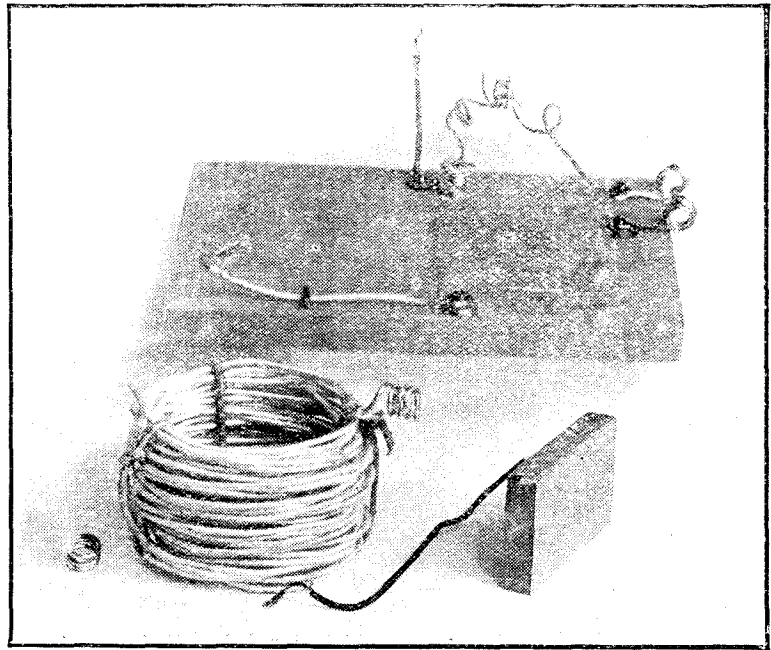

Ready for assembly.

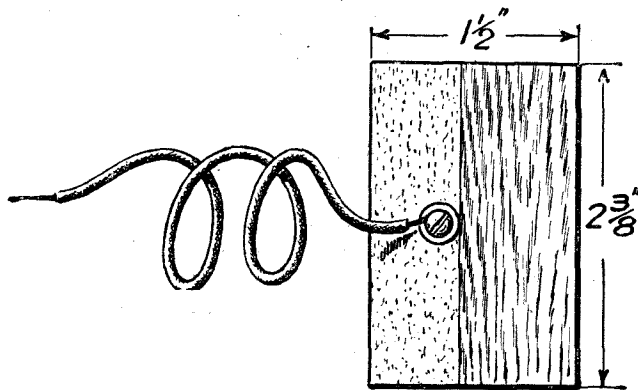

How to make the variable condenser top.

pennies and a piece of waxed paper left over from the previous experiments, a suitable condenser and leak were soon made. The wax paper was cut to a size that could be folded round one of the pennies, leaving some paper projecting on each side. The other two pennies were placed one on each side of the waxed paper and before the paper clip was applied a piece of flexible wire was placed against the upper penny and another between the waxed paper and the inner penny. The paper clip held all three pennies together and at the same time clipped the wires.

For the grid leak I took a piece of sewing cotton, well wetted. This was connected to the two wires leading to this grid condenser. The valve we had was of the dull

emitting type taking only .06 of an ampere. This we simply laid on the table so that its legs projected sideways. One wire of the grid condenser was now connected to the aerial connection of the crystal tuner, the other wire being taken and wound round the grid leg of the valve. Two dry cells were quickly commandeered from the electric bell supply, connected together and the two ends taken to the filament legs of the valve, which promptly lit up. In passing, I must mention that the maximum voltage from two cells will not hurt the valve when no rheostat is used. A wire was also taken from the positive terminal of the dry cell to the earth connection of the crystal tuner, the phones, of course, having been removed from the set. The next

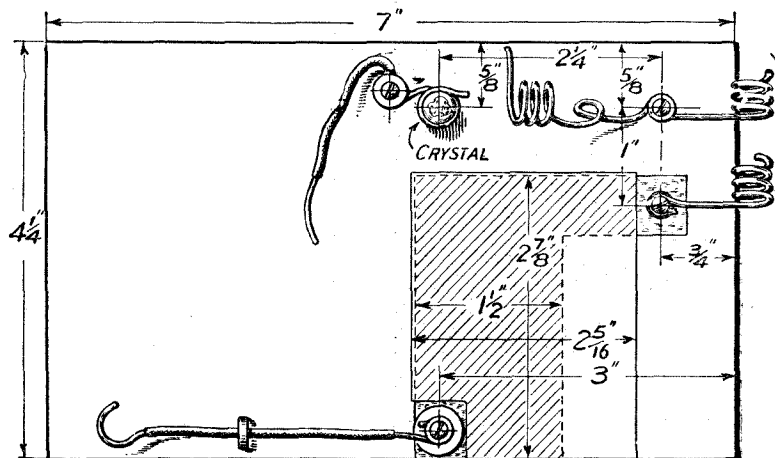

Plan view of the board. Notice particularly that the shaded portion represents tinfoil. The waxed paper covers all but the small portions to which the wires are attached.

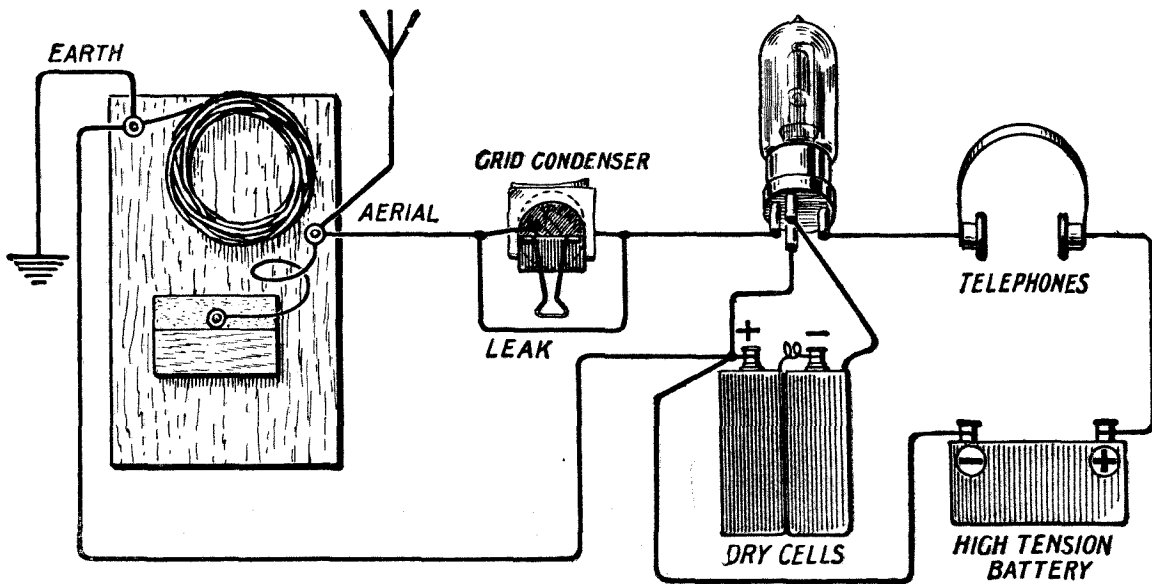

How to join up the tuner for valve work.

step was to take a wire from the plate leg of the valve to one side of the telephones, the other side of the telephones being connected to the positive of the high-tension battery. The negative side of the high-tension battery was now connected to the positive terminal of the dry cell and our set was complete. The only adjustment

necessary was the tuning as before, by sliding the piece of wood over the waxed paper.

In conducting our experiments, of course we had to be very careful not to connect the wires to the wrong terminals and to keep the high-tension leads well away from everything else. Occasionally, too, the cotton grid leak had to be rewetted.

When you have performed these experiments you will realise how simple a valve set, as well as a crystal set, can really be. In the next number I hope to tell you how to make a much more businesslike and practical valve set of a simple type from components that can be bought for a few shillings.

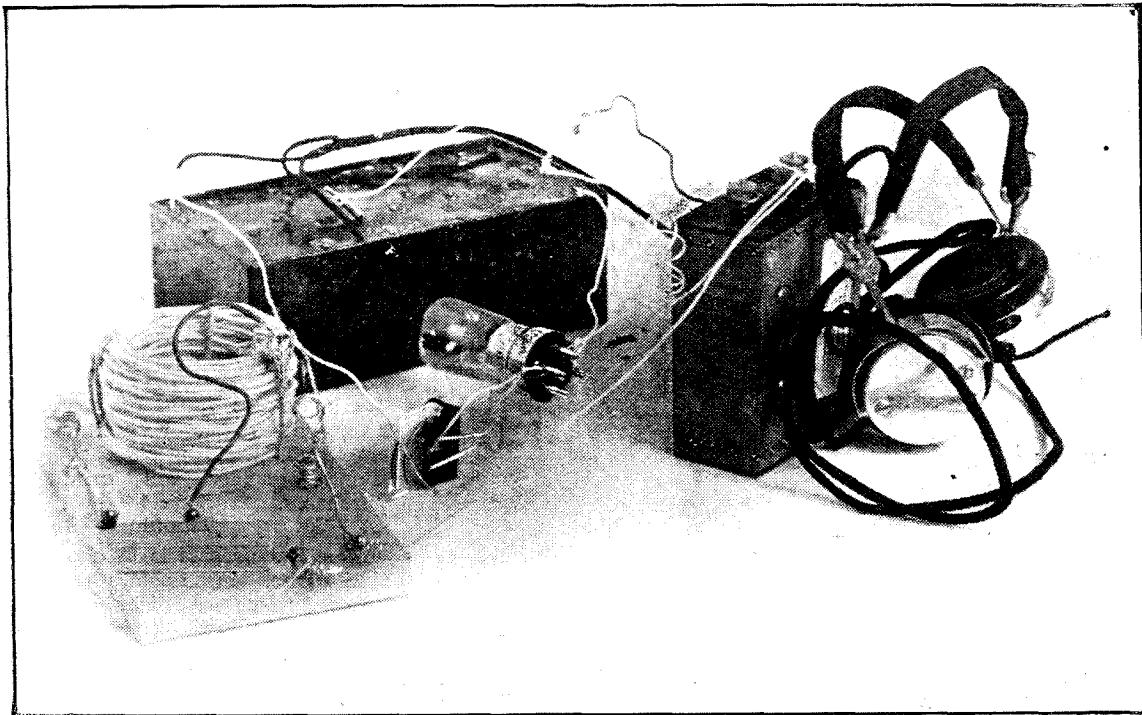

The set in actual use : it gives remarkable results even with an indoor aerial.

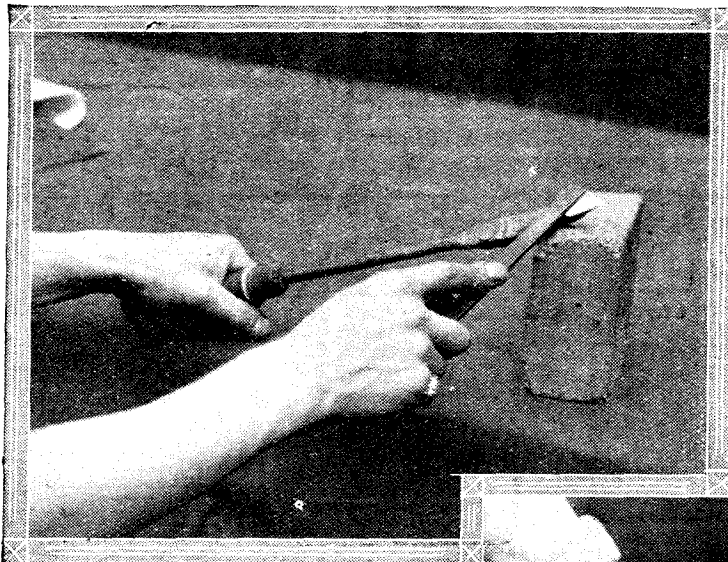

Fig. 1.—First clean your "iron."

MANY novices at the wireless game fear to attempt soldering because they think that it is a very difficult thing to do properly. They may have read, from time to time, such things as "Keep the iron just at the right heat," "Always be sure your iron is properly tinned," or "Thoroughly clean the work before commencing to solder," and have felt quite at a loss to know how to tell, for example, when the iron is hot enough.

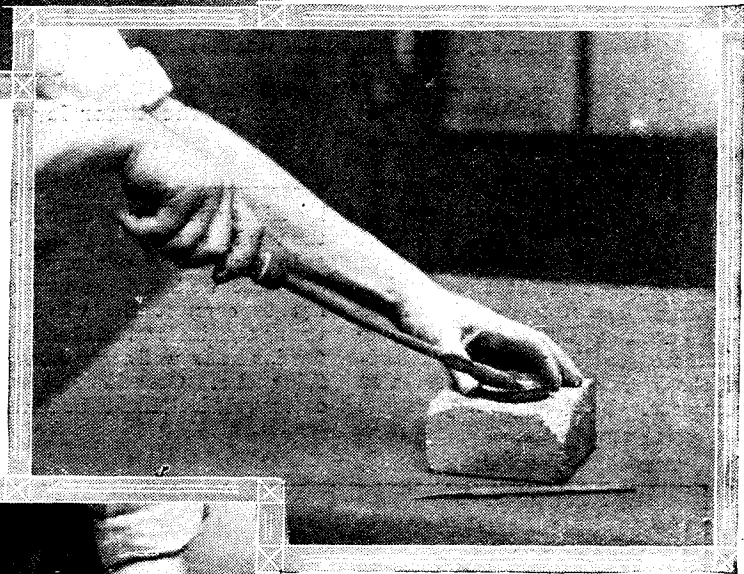

Fig. 2.—Tinning the end.

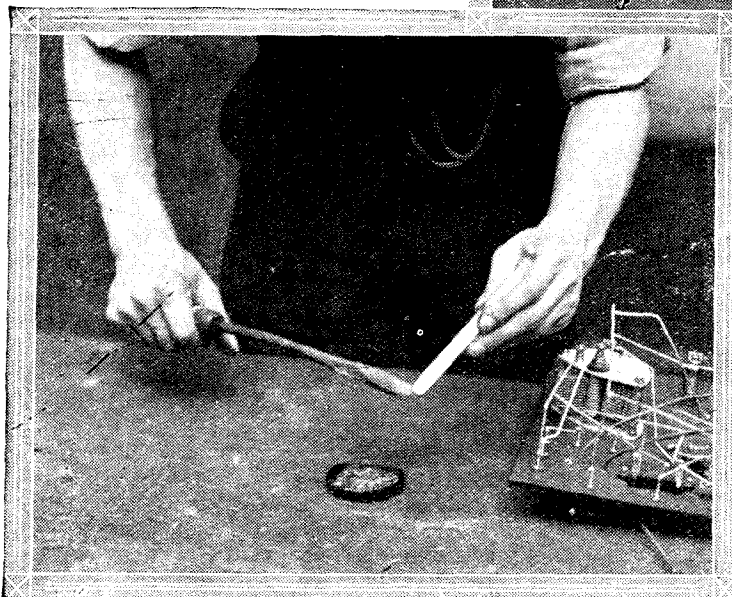

Fig. 3.—Applying the solder.

When the novice has followed out these notes, he will be able, with a little practice, to solder his joints quite well, and therefore to make a much better job of his wireless set than his friend who has never taken the trouble to learn to solder.

How to Solder

*Hints and Tips
on a Useful Art*

By

Herbert K. Simpson

*Sound Soldering means
a Sound Set.*

First of all, the necessary articles must be purchased. All that we need will be a soldering-iron, a file, flux, and some solder. A medium size iron should be chosen, with a fairly pointed bit (the bit is the lump of copper at the end) to enable the iron to poke its way into awkward corners.

A flat file will be quite suitable, but do not buy one that is excessively rough. Some form of non-corrosive flux, such as resin or Fluxite should be employed, while a stick of ordinary tinman's solder will complete the purchases.

Tinning

The first process is to clean up and tin the iron. Fig. 1 shows how to clean up the surface of the iron. Resting the iron on a block of stone or wood, rub the surface with the file to remove any

"pits" or little holes which are often found on the surface of even a new iron, and finish off with a piece of emery cloth. Now, place the iron in a flame, such as that of a Bunsen burner (or alternatively a bright fire, provided there are not a lot of



Fig. 4.—Bending square section wire.

smoky coals burning, will do) for a few minutes. Remove the iron and hold it about an inch away from the cheek. If it feels really

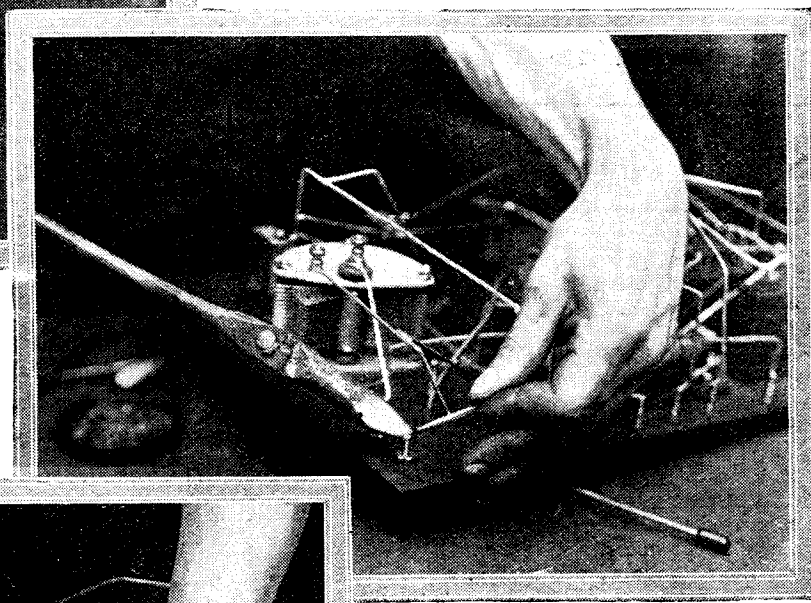

Fig 5.—Tinning the terminal shank.

Practise first.

Before commencing work upon a set, some practice should be obtained upon some scrap. Obtain two pieces of copper wire, say, about No. 24 gauge, or thereabouts. Rub the end of each piece with emery cloth, to clean it up thoroughly, and then twist the two ends together tightly and closely, and apply some flux. When hot enough the iron should be rubbed over with a piece of rag, and some solder is then applied to the tinned surface. This is done by passing the stick of solder over the tinned surface of the iron, in contact with it, as seen in Fig. 3, until a blob of molten solder is adhering to the iron. The wires to be joined are laid upon a block of wood or stone and the surface of the iron upon which the solder is adhering is passed slowly over the joint. The solder should run freely over the wires and, when cool, the joint will be found quite strong and well made. If the solder does not run freely, either the iron is not hot enough, the work is dirty, or insufficient flux has been used, and another attempt should be made.

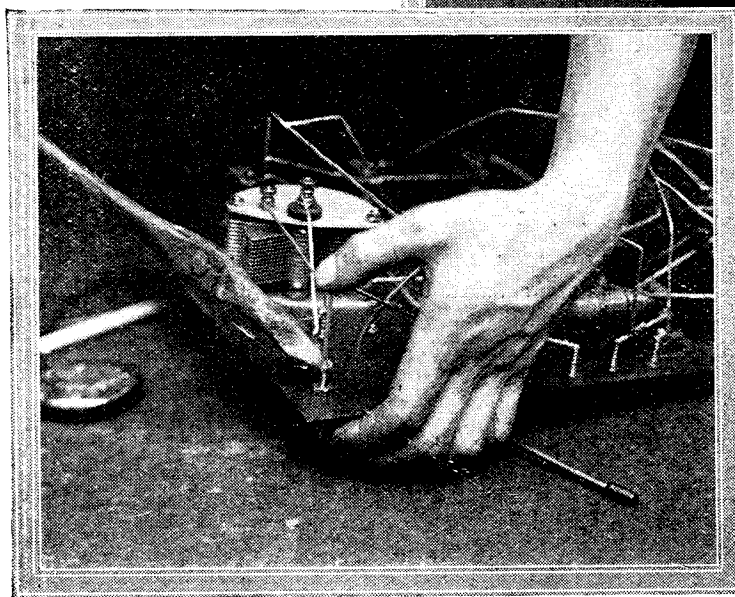

Fig. 6.—The final process.

hot, we can proceed to the operation of "tinning." It may be a little difficult at first to tell just when the iron is hot enough, but with practice the exact temperature will be easily recognisable.

While the iron is heating, obtain a tin lid (that of the Fluxite tin will do admirably) and put a little

of the flux in the lid (Fig. 2 shows how to tin the iron). On removing from the flame or fire, quickly clean up the surface with emery cloth, and, holding the iron in the left hand with the bit over the tin lid, dip the end of the stick of solder in the flux and apply with a sweeping motion to the point of the bit. A few drops of solder will run over the surface of the iron, while some may adhere to it. By rubbing the point in the flux in the tin lid, with perhaps a little more solder, a perfectly clean silvery surface will result, and this condition should be reached before proceeding further. Each surface should be tinned in this manner and the iron may be returned to the flame in preparation for the actual work to be done. Great care must now be taken in seeing that the iron does not become overheated, as if this occurs, the tinning will be burned off, and we shall have to start all over again.

Wiring with Square Wire

A set may be made to look exceedingly neat and workmanlike if wired with square section wire, and as this method of wiring is really quite easy, there is no reason why every set should not look well-made. Fig. 4 shows how to bend the wire to the correct shape. A pair of flat-nosed pliers will be required for this work, the wire being held in the pliers and bent to the desired angle by the thumb or fingers of the left hand, whichever the constructor may find most convenient. Each piece of wire should be carefully bent to the exact shape to fit between two points, such as a terminal and the lug of a condenser, for example, before soldering is commenced. The shank of

the terminal must next be tinned. Put some solder on the hot iron, as seen in Fig. 3, and apply some flux to the terminal shank with a match stick, as seen in Fig. 5. The iron is applied to the terminal shank, and the solder should run well over the portion to which the flux was applied. The wire itself is now cleaned and held in position over the terminal, Fig. 6. Some more solder is put on the iron, and a little more flux may be put on the joint. Application of the iron to the joint will cause the solder to run and a firm joint will result.

Don't use too much solder. Use as little as possible, provided you make a good joint. The same remark applies to the flux. If you use too much of these materials, you will find lumps of solder all

over the panel, and the flux will form a greasy layer which is detrimental to the insulating properties of the ebonite. A very good plan is to wash the panel over with petrol after soldering, if the flux has spluttered. Cases of inefficiency have been traced to a deposit of spluttered flux in between valve legs behind the panel, so be sure to clean away all traces of flux after the job is finished.

A FINAL NOTE.

A final word. Don't get disheartened if your first attempt should not prove a success. Remember we all have to learn, and when success does come, it will well repay any time spent in practising with odd pieces of wire.

A SIMPLE POLARITY INDICATOR.

WHEN charging accumulators it is always necessary to know which terminal of the mains is positive and which is negative.

This may be determined very simply by placing two leads from these terminals in water. The wire on which most gas is formed is the negative, and should be connected to the negative terminal of the accumulator. The reaction is increased if a little sulphuric acid is added to the water. Vinegar will do in the absence of other acid.

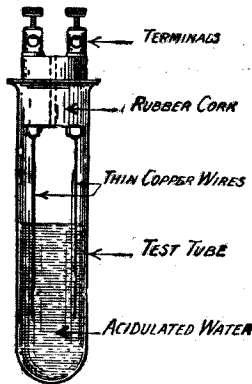

A polarity indicator.

A neat form of indicator may be constructed in a glass test tube. A rubber cork is fitted to the tube through which two small terminals pass. These each have soldered to their ends a length of thin copper wire. The accompanying sketch will make the construction clear. It is advisable to drill a small hole through the stopper to allow the gas to escape.

A FEW "DON'TS."

DON'T expect to receive signals if your earthing switch is in.

DON'T burn dull-emitter valves too bright in order to see if you get better signals. The filaments may not burn out, but the dull-emitting properties of the valves will be impaired.

DON'T expect a high-tension battery to last for ever. It deteriorates in time, even if not used.

DON'T take risks with the high-tension leads. Valves are expensive!

DON'T leave valves lying about on the table. They roll off far too easily.

DON'T forget to switch off your accumulator in the long intervals. You will need the current later.

DON'T leave your accumulators uncharged. Charge them again immediately they run down.



AERIAL WARFARE IN OUR SUBURB

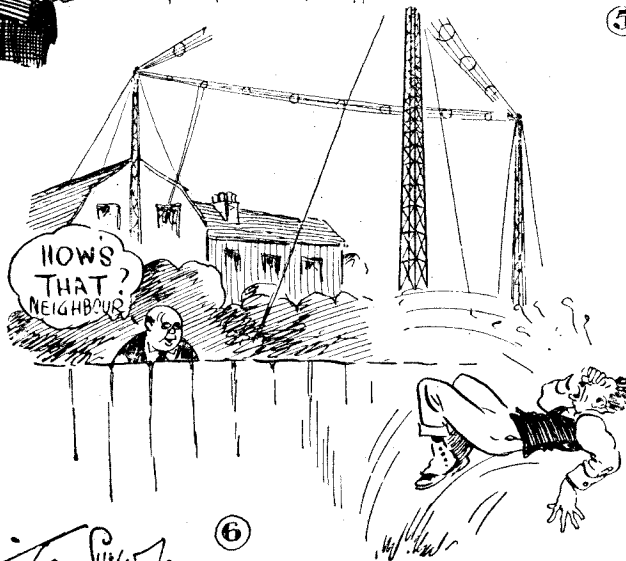
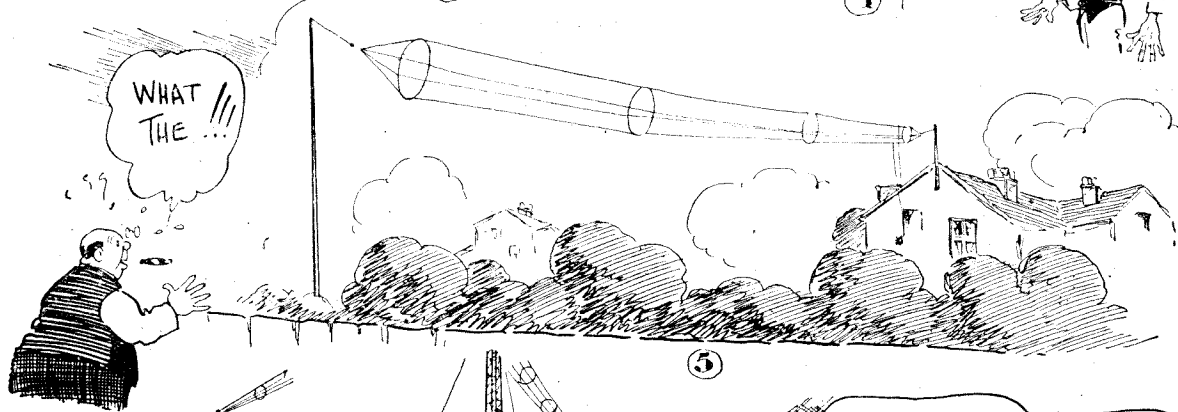
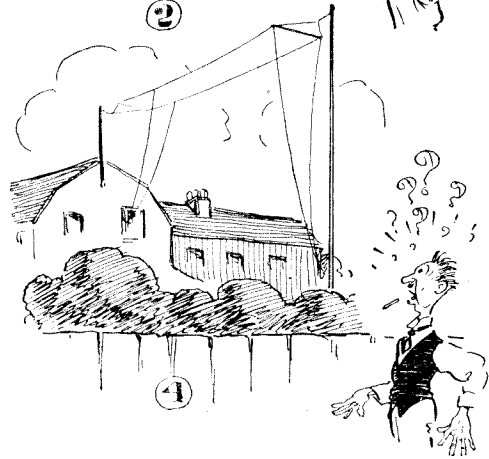
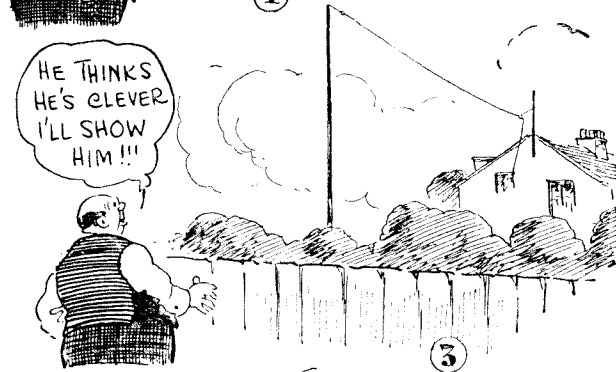
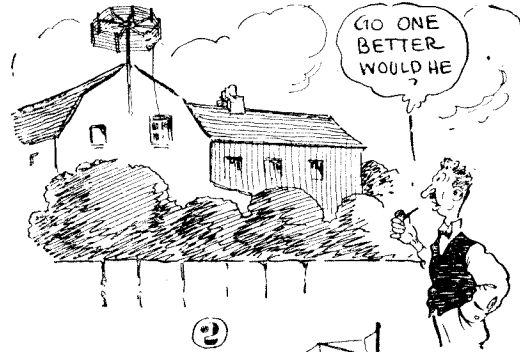
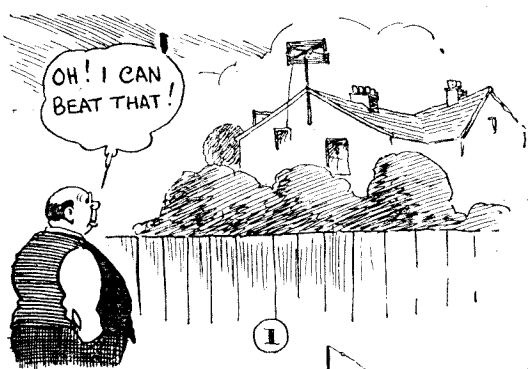

Ken Sibley 1924

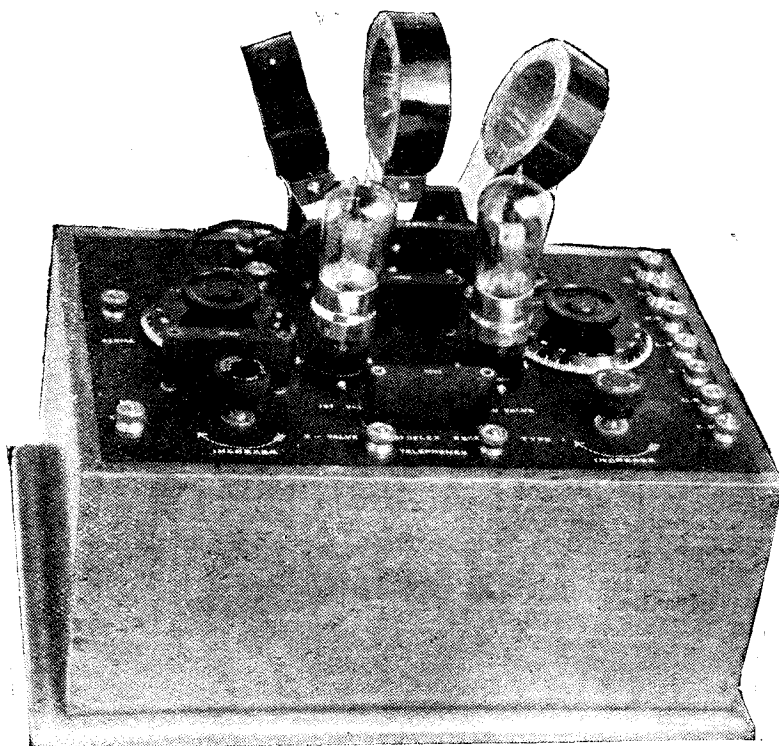

Fig. 1. Here is the Resistoflex complete with coils.

FOR the last three years I have been endeavouring to produce an effective reflex circuit which would give loud-speaker results within a reasonable distance of a broadcast station, and yet not to have to rely upon the instability of a crystal receiver or skilled operating ability.

The S.T. 100 has probably been made by at least 50,000 constructors in this country, if the sales of Radio Press Envelope No. 1 are anything to go by. Constructors on every hand have written glowing letters praising the results of this set—results which, in most cases, are better than those I have obtained myself!

S.T. 100 and Distance

Although the S.T. 100 receiver is a very powerful one and will work a loud-speaker with the greatest of ease, yet, in spite of the many reports to the contrary, it is not, in my opinion, ideal for long distance reception, and it also suffers under the disadvantage of the necessity for a crystal detector, and this, of course, is the weak point in the whole receiver. A poor crystal or a faulty adjustment and the results are very inferior. Moreover, the presence of two step-up trans-

formers greatly increases the tendency to buzz, which is so prevalent in reflex or dual amplification circuits in which one or more of the valves act, not only as a high-frequency amplifier, but also as a low-frequency magnifier.

The Ideal Reflex

Whether it is possible to produce the ideal reflex set or not I cannot say at present. With a single valve it is, of course, necessary to have a crystal detector to get a proper dual effect. When two valves are used, however, either a crystal or the second valve may be used as the detector. The use of a crystal detector enables both valves to be used as low-frequency amplifiers, whereas if a valve is used as a detector, only one of the valves may be used as a low-frequency amplifier. Consequently, the S.T. 100 will always have the merit of getting the maximum out of the valves as regards low-frequency amplification, because no one can deny that an iron-core step-up transformer gives the best signal strength in low-frequency amplifiers.

The instability of reflex receivers is due to so many causes that a full investigation into them all has taken a very great deal of experimental work. It is not so much a question of the arrangement

The Resistoflex Receiver

This set represents the result of three years' endeavour to produce a thoroughly stable reflex receiver.

of components on a panel as the actual fundamental evolution of a suitable circuit. One of my principal contributions to the design of reflex receivers is in connection with the feeding back of the low-frequency currents into the aerial circuit instead of between earth and filament battery. There are further methods of increasing the stability of the S.T. 100 and other reflex circuits, and some of these are given in a constructional article in "Wireless Weekly" of October 22.

The fact remains that even when all these modifications have been made, there remains a fundamental reason for buzzing in reflex circuits which it is almost impossible to avoid.

Nothing to Buzz

In the Resistoflex circuit, however, I have at last found a solution of this problem, and this lies in providing nothing to buzz. This may seem very simple, but the solution of the problem has evaded investigators for over ten years. Put a little more scientifically, I cut out any resonant low-frequency circuit from any part of a reflex circuit where it could cause trouble. The principal cause of trouble in reflex circuits is the resonant circuit produced by the transformer which feeds back the low-frequency currents into the grid circuit. The low-frequency resonant circuit consists of an inductance which consists of the windings of a transformer wound on an iron core, and a capacity which is either the self-capacity of the windings or this capacity to which is added a condenser connected across the windings. If such a circuit is cut out altogether from a reflex set, the stability is enhanced very greatly, and in this Resistoflex

By
John Scott-Taggart
F.Inst.P., A.M.I.E.E.

This article, by the inventor of the famous S.T. 100 circuit, gives practical details of a set which promises to outrival even the S.T. 100 in popularity.

circuit I obtain this effect by feeding back the low-frequency currents through a resistance connected in the grid circuit of the first high-frequency amplifying valve. A valve is used as a detector working on the leaky grid principle, and the rectified currents in the anode circuit of the valve are fed through an anode resistance which is included in the grid circuit of the first valve. The low-frequency current variations passing through this resistance set up potential differences across it, and these are communicated to the grid of the first valve and are amplified by it.

The Anode Circuit

In the anode circuit of this valve we have telephones or a loud-speaker, or preferably another high resistance which is connected to a third valve.

As, however, most of the readers of THE WIRELESS CONSTRUCTOR

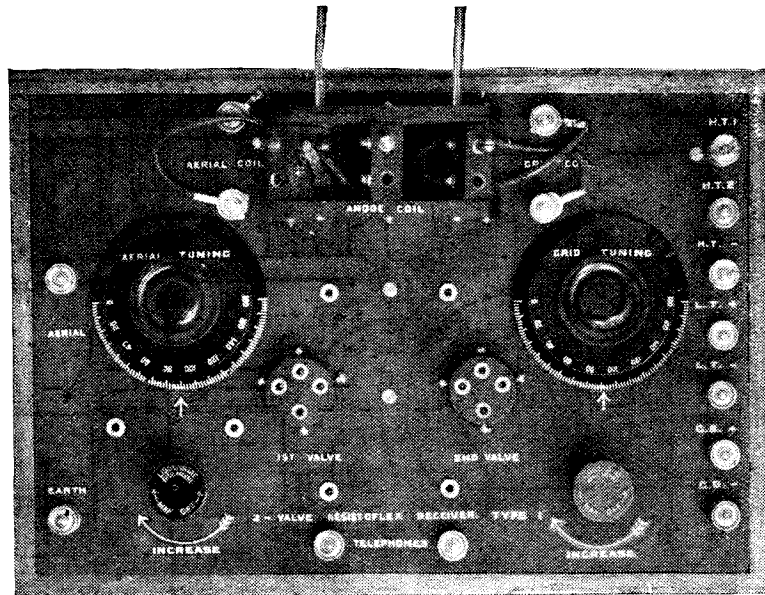

Fig. 2. Plan view of the Resistoflex two-valve set.

will be first of all interested in a two-valve set, I propose to deal only with a really efficient two-valve receiver working on the Resistoflex principle.

The Results Obtainable

The results obtainable with the particular set about to be described are very good, and at 10 miles from 2LO I can get really loud loud-speaker results on quite an ordinary outdoor aerial. The set, of course, gives several times louder results than the S.T. 34. The strength of signals, I find, is somewhat less than that given by the S.T. 100, but on the other

hand I have personally found the receiver more effective for longer ranges. The superiority of the S.T. 100 is more marked when only a short distance from a broadcasting station, but the Resistoflex possesses many advantages which the S.T. 100 cannot boast. There is no crystal to go out of adjustment, and it is impossible to make the set buzz. Reaction, on the other hand, can be very carefully adjusted, and the set is as effective on 5XX as on the shorter wave stations.

Other Stations

Two or three of the other broadcasting stations can be heard on the phones, but a much better idea of the full capabilities of the set will be obtainable when the reports come in from experimenters who have built up a set embodying this circuit. I can only say that I am extremely satisfied with the results myself, and I firmly believe that there will be a very great vogue for this particular circuit.

Appearance of Set

The set has a very pleasing appearance, as will be seen from Fig. 1, and it will be seen that a three-coil holder is employed. Those who read my article on the Resistoflex circuit in the issue of "Modern Wireless" of October, and those who read my article on tri-coil circuits in the September issue of that magazine, will realise

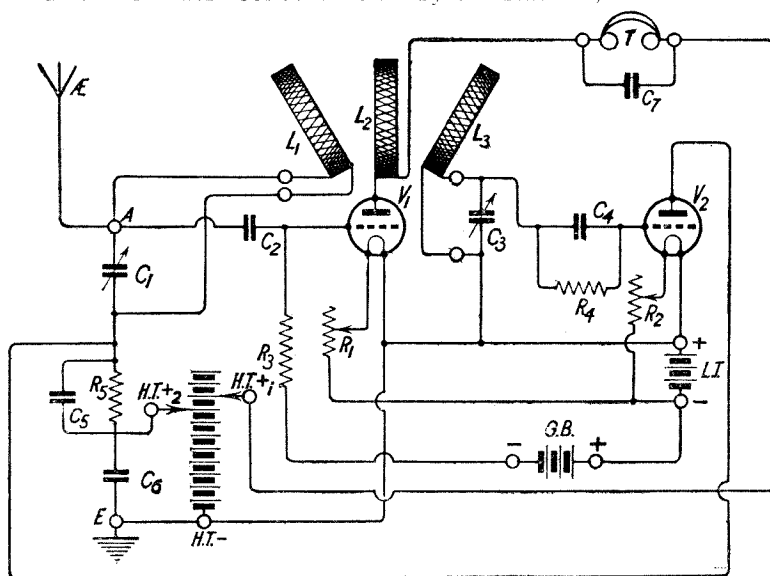

Fig. 3. The circuit has many points of interest.

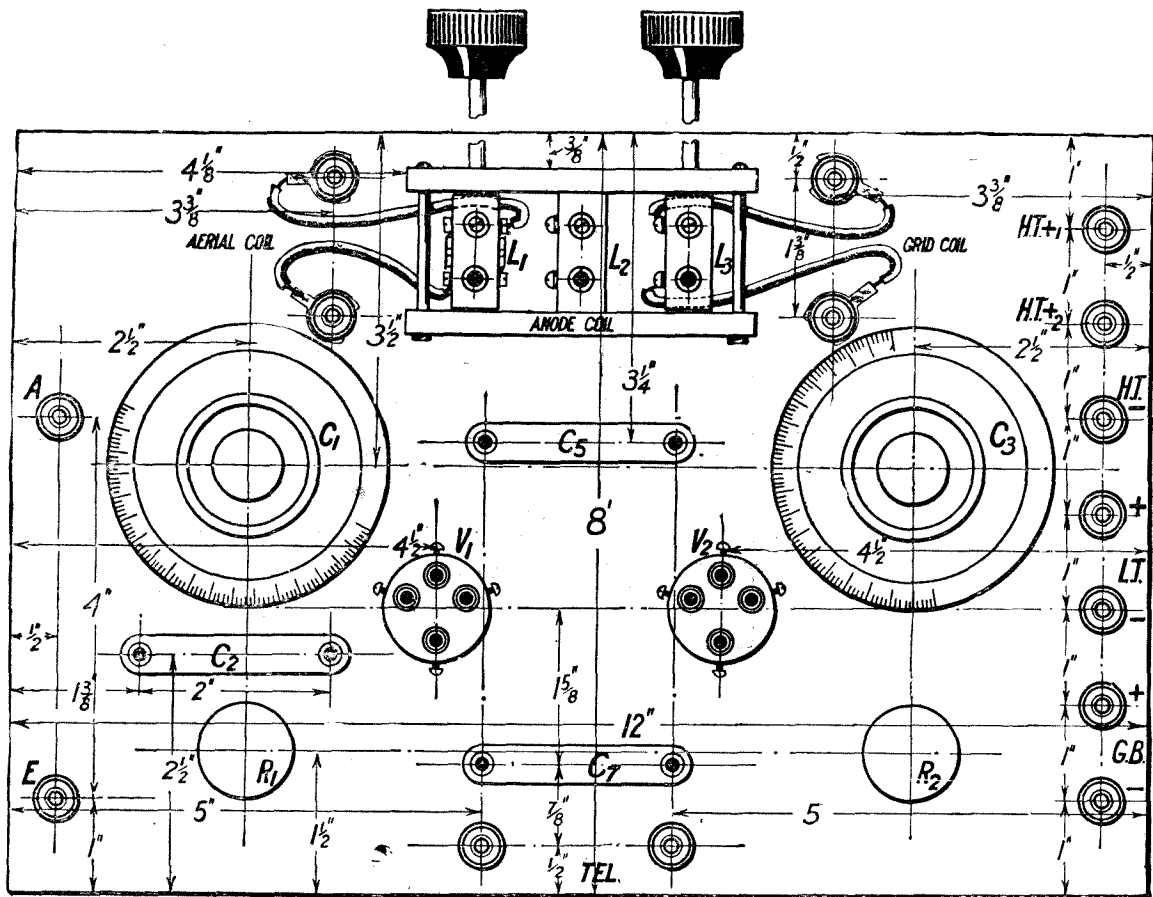

Fig. 4.—Drilling and marking diagram of the two-valve Resistoflex

that I have adapted the tri-coil system to the Resistoflex

The set is very compact, and there is a single aerial terminal and a single earth terminal. The telephone terminals appear in front of the set and there are seven terminals down the right-hand side of the cabinet. The top terminal is one of the high-tension positives, while the second one is another high-tension positive. The next terminal, the third, is the high-tension negative, while there are two terminals for the low-tension battery, which will usually be a 6-volt accumulator. The two lower terminals are marked G.B.+ and G.B.-, and across these terminals a small battery of about 3 volts is connected, so that G.B.- is connected to the - terminal of the battery, while G.B.+ is connected to the positive terminal. The H.T.₁+ and H.T.₂+ terminals may both be connected together by a wire during preliminary experiments and one terminal is then joined to the positive terminal of the high-tension battery, while the negative terminal of this battery is connected to the terminal marked H.T.-, which is the third terminal

of the set from the top. Those who desire to carry out experiments may care to try different values of H.T. for the first and second valves respectively, in which case H.T.₁+ may be connected to one wander-plug in the high-tension battery, while H.T.₂+ is connected to another wander-plug. These plugs may be varied up and down the battery for experimental purposes. The H.T.- terminal, of course, is on the negative socket of the high-tension battery.

The Aerial Tuning Condenser.

The aerial tuning condenser is a .0005 μF variable, and may be of either the ordinary type or a square law condenser. The latter type is to be recommended, although not actually used in this set. There is no need to specify the particular make of variable condenser employed in the set, because any condensers advertised in this journal will be found satisfactory. The same really applies to the three-coil holder, and it will be noticed that the two outside coils have flexible leads connected to them which go to two terminals.

Reversing Coil Leads.

These flexible leads enable the connections to the outside coils to be varied in respect of the two terminals provided, which is equivalent to reversing the leads to the coils. The grid coil, which is in the grid circuit of the second valve, is not so important as regards the connections as the aerial coil, which affects the reaction obtained. When this aerial coil is close up to the middle coil, or anode coil, either a reaction effect will be obtained, or reverse reaction. If signals are weakened by bringing up the aerial coil to the anode coil, after retuning the two variable condensers, the leads should be reversed. It is best to have the aerial coil at right angles to the anode coil when first commencing operations, and to have the grid coil, which is in the grid circuit of the second valve, close up against the anode coil.

Coils Needed.

To receive the B.B.C. stations the aerial coil may be a No. 50 or a No. 75, while the anode coil is a No. 75, as also is the second grid coil.

As regards valve holders, I very strongly advise the purchase of the special low-capacity valve holders which are much to be preferred. These holders are sold by various firms, and any of these types may be employed. H.T.C., Gamages, Goswell Engineering Company, and other firms supply suitable valve holders.

The two rheostats used in this particular set are Lissenstats, but Lissenstat minors will do just as well. Excellent rheostats for a set of this kind are also made by Burndept's and Radio Communication Company Limited. The panel, however, would have to be larger for these latter.

The beautiful finished appearance of the set is largely obtained by the use of the "Radio Press Panel Transfers," which are obtainable in sealed envelopes at any wireless shop, or any newsagent or book-seller.

List of Components

The parts needed to make this receiver are as follows:—

Ebonite panel, 12 ins. by 8 ins. by $\frac{1}{4}$ in.

Radio Press Panel Transfers.

Cabinet of correct size for above panel.

- 1 three-coil holder.
- 1 0.0005 μF variable condenser.
- 1 0.0003 μF variable condenser.
- 2 Lissenstat filament rheostats.
- 2 valve holders.
- 1 2 μF Mansbridge condenser.
- 1 .0003 μF fixed condenser with clips (Dubilier).
- 2 2 megohm grid-leaks (Dubilier).
- 1 100,000 ohm mounted resistance (Dubilier).
- 2 .0003 μF fixed plug-in condensers (Peto Scott).
- 1 .0005 μF fixed plug-in condenser (Peto Scott).
- 6 sockets for plug-in condensers (Clix).
- 15 W.O. type terminals.

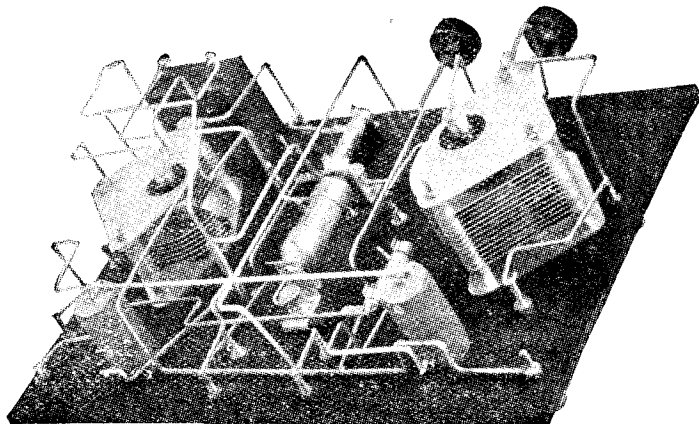

Fig. 6.—A view from another angle.

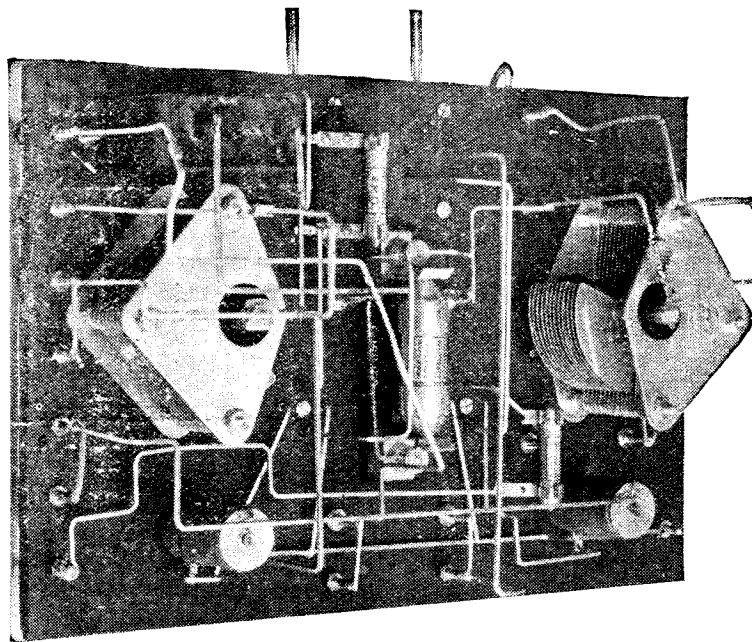

Fig. 5.—Back of panel wiring.

Quantity of square-section wire.
Screws.

Small quantity rubber-covered flexible wire.

Pair of clips for Dubilier grid-leak.

A Top View

Fig. 2 is a top view of the receiver, and the general lay-out of the parts will be noted. Fig. 4 is an accurate scale drawing of the top panel drawn half-size, while Figs. 5 and 6 show the rear views of the set. Three fixed condensers, which are seen in Fig. 1, are of the Peto-Scott type; the condenser to the left of Fig. 1 is a .0005 μF , while the condenser at the back just in front of the three-coil holder is a .0003 μF , while the one to the front in the middle is also a .0003 μF . These condensers

are of a very ingenious pattern, and fit into Clix sockets mounted in the panel. The grid condenser of the second valve is of Dubilier manufacture, as also are the two gridleaks of 2 megohms value each, and the anode resistance of 100,000 ohms.

The Circuit Diagram.

Fig. 3 shows the circuit diagram of the Resistoflex receiver. It will be seen that the aerial circuit consists of the inductance L_1 shunted by the variable condenser C_1 which has a capacity of .0005 μF . The condenser C_5 has a value of .0003 μF and is shunted across the resistance R_5 which has a fixed value of 100,000 ohms. It is essential that this resistance should be of high-grade quality and, generally speaking, I prefer a fixed resistance. The condenser C_6 has a capacity of 2 microfarads (μF); this condenser is of the Mansbridge type, but the actual value is not very important. The condenser C_2 has a capacity of .0005 μF , while R_3 and R_4 are gridleaks having a value of 2 megohms each.

Condenser Values

The variable condenser C_3 has a maximum capacity of .0003 μF , although a .0005 μF variable condenser would do. The condenser C_4 is the usual grid condenser and has a fixed value of .0003 μF . The condenser across the telephones T marked C_7 , in the diagram, has a fixed capacity of

.0003 μ F. Instead of telephones, of course, a loud-speaker could be used, as the set will easily work a loud-speaker up to 15 miles at least.

It will be seen that separate tappings are taken from the high-tension battery, these tappings being H.T.+1 and H.T.+2. The little circles in this circuit diagram represent terminals on the actual set. The battery marked G.B. is provided to enable the grid of the first valve to be given a negative potential through the resistance R_3 . This I found to be very desirable.

Grid Bias

The value of the battery G.B. will depend largely upon the type of valve used for V_1 , but 3 to 4

volts was found most suitable for "general purpose valves." The cells in an ordinary flash-lamp battery may be used for this purpose, and by scraping off the pitch it is possible to take tappings of the three cells inside the battery, each cell giving $1\frac{1}{2}$ volts approximately.

Signals will still be obtained without a grid battery by joining the grid battery terminals by a piece of wire, but the signals will not be as good or as pure.

This circuit has the interesting advantage that the first valve may be used as a receiver complete by simply turning out the filament of the second valve and moving the coil L_3 away from L_2 . If this is done the grid battery should not be used, but the grid battery

terminals should be shorted by a wire.

For ordinary broadcast stations L_1 may be a 50 or 75 coil with L_2 a 75 and L_3 a coil of the same size.

The H.T. Battery

The high-tension battery should preferably go up to 100 volts.

This article will be concluded in next month's issue (out November 15th) and a full-sized wiring blue print will be presented with each copy of "The Wireless Constructor."

An Easy Method of Tinning.

IT is always advisable to tin the ends of terminals and studs, etc., before placing them in position on the panel. Much trouble is saved by so doing.

The easiest way to tin a number of things is as follows:—Procure a small tin lid, a cocoa tin lid suits admirably, and melt some solder in it over a gas flame. The solder should flow very easily and should not be thick or the operation will fail.

Hold the terminal, or whatever it is required to tin, in the flame until it is very hot. Then dip it into the flux. It will then be bright and clean. Transfer this to the tin of melted solder, taking care that it becomes properly hot. Withdraw from the solder and shake any surplus metal off. Wiping with a dry rag will also remove this. If the terminal, etc., has been made properly hot, no metal will remain in the threads and prevent a nut passing over it.

The heads of wood screws may be tinned by the same process. If all the terminals and components on a set are plated, it looks out of place to see brass fixing screws holding the panel to the cabinet. Brass screws with tinned heads will probably not look as good as plated screws, but the general effect will be more pleasing than the ordinary brass screws.

THE GERMAN STYLE



Wireless apparatus on board a German liner. The style differs from that on the British ships.

Six Popular Circuits in Pictures

This article will show you how to wire up a circuit even if you have no previous experience whatever.

THIS series shows six well-known circuits in pictorial form, this method of illustration being adopted to enable the veriest novice to wire up any of the circuits successfully, should he so desire. It will be seen that similar valve panels are used in each case, and these are so simple that a very brief description will suffice to make the construction clear. If desired, an old panel containing a valve holder, filament rheostat and a few terminals may be employed, but if it does not conform to the following description as regards the wiring, it should be altered to do so.

The components are: an ebonite panel large enough to take the valve holder, rheostat, and terminals

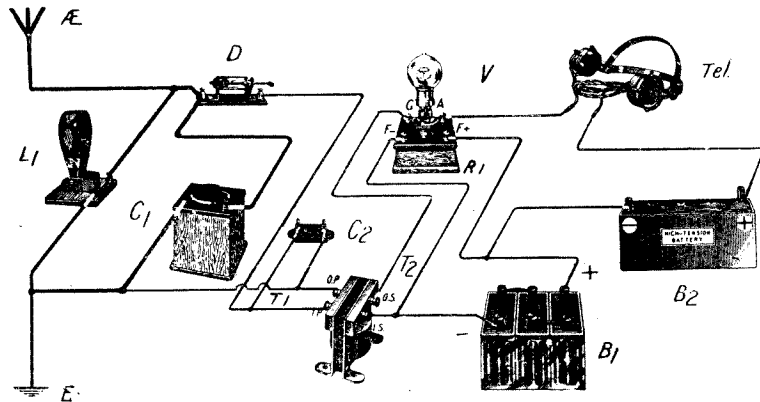

Fig. 1.—Crystal detector and one note magnifier.

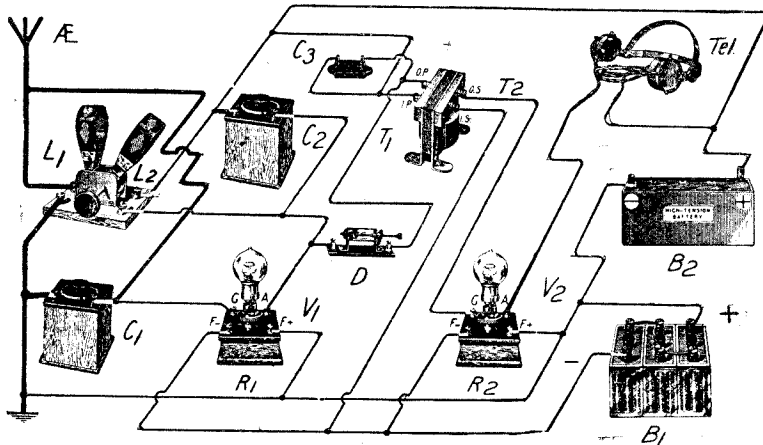

Fig. 2.—High frequency crystal detector and one note magnifier.

without crowding (say 7 in. by 5 in.); a box of dimensions to suit the panel, a filament rheostat of a type suitable for the valve to be used, a valve holder, and four terminals. These latter are marked in every illustration, and their inside connections should be noted carefully. F+ goes direct to a filament leg of the valve holder; F- goes to one side of the rheostat, the other side of this latter being connected to the other filament leg. Terminal G is connected to the grid leg, and A to the anode or plate leg.

Now to come to the actual circuits, Fig. 1 shows a crystal detector followed by a stage of low-frequency amplification. The different parts may be arranged in convenient positions on a table

or a board, and this applies also to the circuits which follow. L₁ is the aerial tuning coil of the plug-in type, its size being governed by the wavelength to which it is desired to tune. C₁ is the aerial tuning condenser, a suitable value being 0.0005 μF. D is the crystal detector, and C₂ a fixed condenser of 0.001 μF; the L.F. transformer is indicated by T₁ T₂, and the filament battery by B₁, while B₂ is the H.T. battery. In wiring up it must be remembered that a small semi-circle in a wire indicates "No connection." The circuit is very simple to operate, the only tuning adjustment necessary being that of C₁.

In Fig. 2 we have the circuit of Fig. 1 preceded by a stage of H.F. amplification. Since similar components in the various circuits are given the same markings, it will be sufficient to give only the

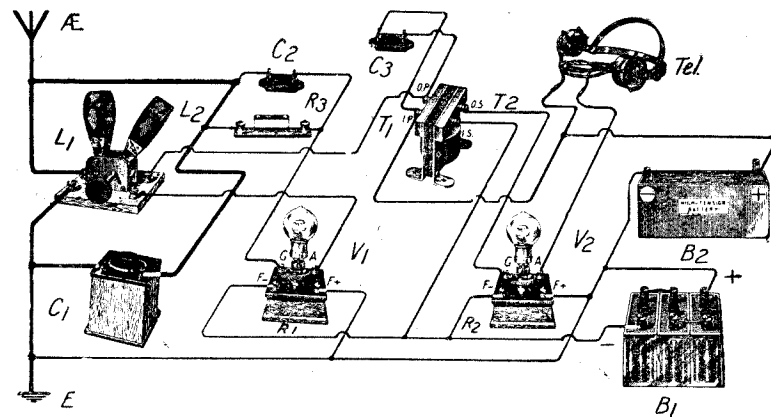

Fig. 3.—Valve detector and one note magnifier.

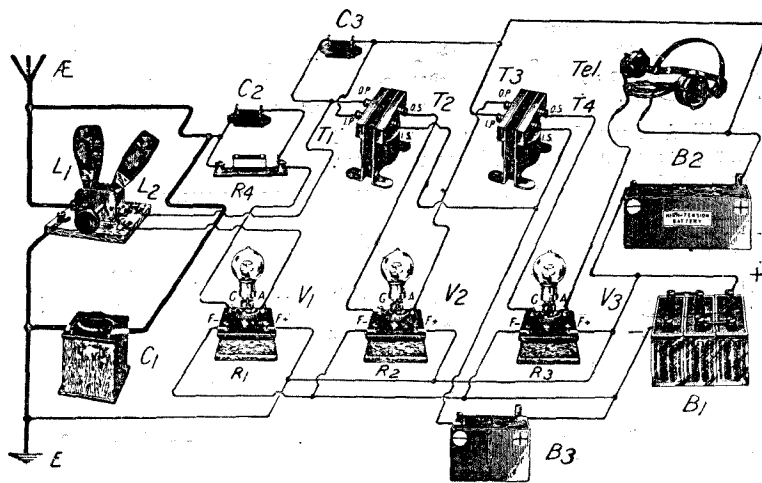

Fig. 4.—Valve detector and two note magnifiers.

values of components where necessary. L_1 and L_2 are the aerial and anode coils respectively, and are mounted in a two coil holder. The values of C_1 and C_2 , the aerial and anode tuning condensers, may be $0.0005 \mu\text{F}$ and $0.0003 \mu\text{F}$ respectively. C_3 is a $0.001 \mu\text{F}$ fixed condenser. When tuning this circuit, L_1 and L_2 should be kept well apart at first, and the effect of bringing them slowly together, retuning at the same time on the two condensers, may be noted after having received signals. In all cases where two coils are coupled in this manner the effect of reversing the connections to one of them should be noted, together with variations of the coupling between them.

A very efficient all-round circuit is that shown in Fig. 3, which consists of a valve detector followed by a low-frequency amplifier. L_1 and L_2 are in this case the aerial and reaction coils, and great care should be taken whilst moving

the latter owing to danger of causing interference. C_1 may again have a capacity of $0.0005 \mu\text{F}$; C_2 and C_3 have respective capacities of $0.0003 \mu\text{F}$ and $0.001 \mu\text{F}$. R_3 is a grid leak of 2 megohms resistance.

In Fig. 4 is depicted the Fig. 3 circuit with an extra L.F. amplifier, the values mentioned in connection with the previous circuit applying equally well here. The grid leak in the present case is marked R_1 . T_3 , T_4 is the second L.F. transformer, and V_3 the additional valve panel. A small battery B_3 is also included in this circuit to apply grid bias to the last valve. A useful voltage is about three volts, when using about 100 volts high tension. If a low value of H.T. is used, less bias is necessary and may frequently be dispensed with.

The Fig. 5 circuit consists of one stage of H.F. and a valve

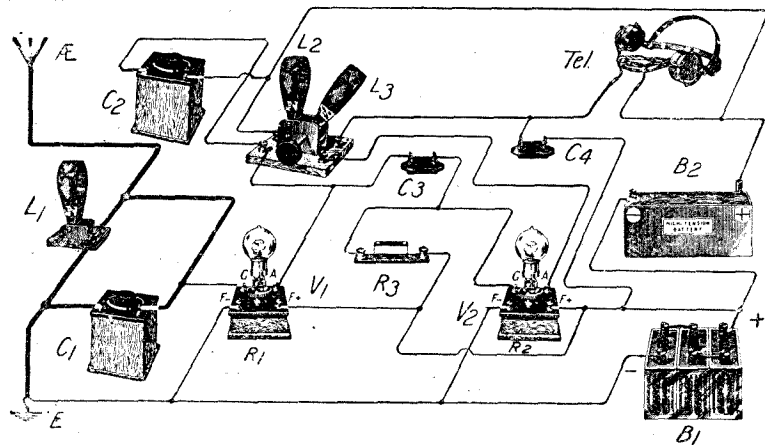

Fig. 5.—High frequency and valve detector.

detector. The aerial coil L_1 is mounted in a single socket holder well away from L_2 and L_3 , which are the anode and reaction coils respectively. Values of components are: C_1 , $0.0005 \mu\text{F}$; C_2 , $0.0003 \mu\text{F}$; C_3 , $0.0003 \mu\text{F}$; C_4 , $0.002 \mu\text{F}$; R_3 , 2 megohms. An excellent circuit for distance reception.

Fig. 6 shows a circuit equivalent to that of Fig. 5, but with a stage of L.F. amplification added. C_1 , C_2 , C_3 , and C_4 may have the same values as in the previous circuit. R_1 has a resistance of 2 megohms.

Regarding the sizes of coils to use in the various circuits, a No. 25, 35, and 50 may be tried in the aerial socket on the usual broadcast wavelengths. The anode coil, when used, should be a No. 50 or a 75 coil, and the reaction coil a No. 75 or 100. For Chelmsford, the coils in the same order are Nos. 150, 250, and 300.

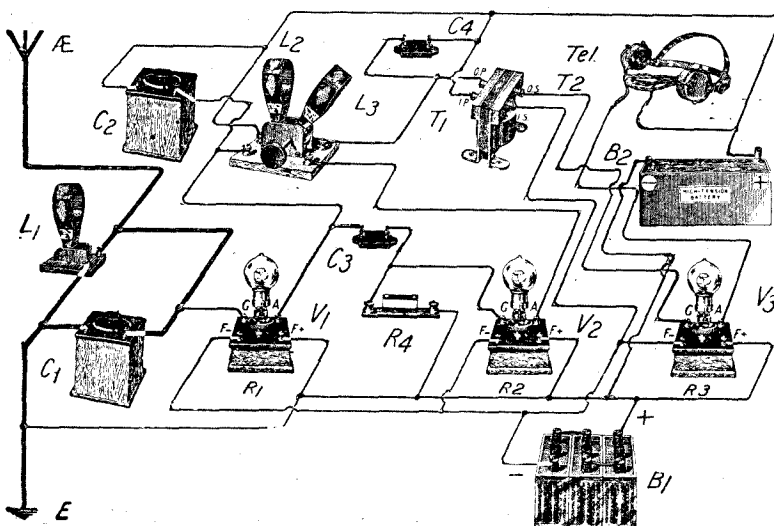
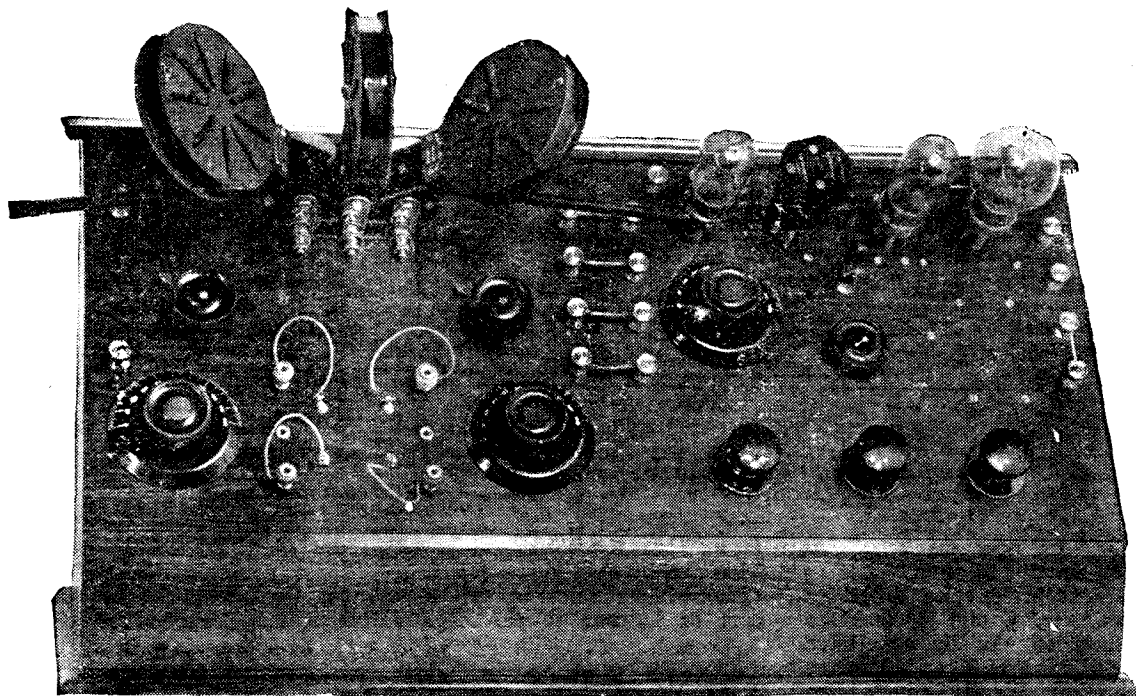

Fig. 6.—High frequency, valve detector and magnifier.



The complete neutrodyne receiver.

A Three - valve Loose - coupled Neutrodyne Receiver

By PERCY W. HARRIS.

This receiver gives remarkable selectivity combined with extremely high sensitiveness. It is the "de luxe" instrument for the discriminating amateur. This article is complete in this issue, but a few operating notes will be given in the next number.

FOR a long time I have been wondering how it would be possible to improve on the selectivity of existing sets without their becoming unduly complicated or of limited range, and I think at last I have succeeded in finding a method which gives not only

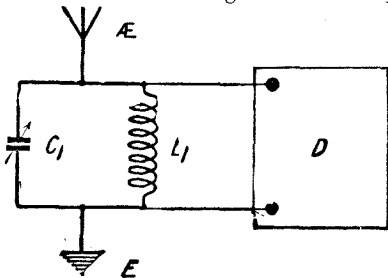

Fig. 1.—A direct-coupled circuit.

very high selectivity, but in addition a great increase in efficiency.

Loose-coupling and its Difficulties

Considered from the point of view of the experimenter who confines work to paper and pencil, the simplest way of increasing the

selectivity of a set is to substitute loose-coupling for the direct coupling generally used. In direct coupling we have the tuning inductance with its associated condenser connected directly in the aerial circuit, the detector being connected across the inductance. There are many theoretical reasons why the selectivity of such a set is low, but its simplicity has made it very popular. If we use a crystal detector or even a valve detector without any stage of high frequency, it is easy to place the detector in a circuit separated from the aerial as shown in Fig. 2. "D" in Figs. 1 and 2 means Detector and may be either a crystal or a valve. L_1 in Fig. 1 can be any kind of inductance, and C_1 can be any type of variable condenser, or C_1 can be omitted and L_1 alone will do provided it is adjustable. In Fig. 2 the inductance is duplicated, L_1 being in the aerial and L_2 in the closed circuit. It is

quite convenient for these two coils to be of the plug-in type in a two coil holder. Two condensers are also needed, one to tune the aerial and one to tune the closed circuit. If the coupling between L_1 and L_2 is variable a very great increase in selectivity is to be found.

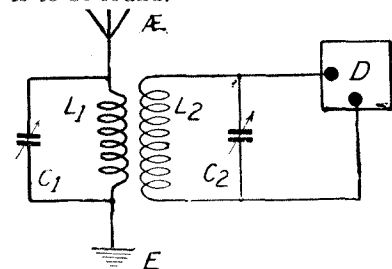

Fig. 2.—A loose-coupled circuit.

Loose-coupling with a Valve

So long as the detector is a valve without a stage of high frequency we shall not have much trouble, save that due to the increase in the number in tuning

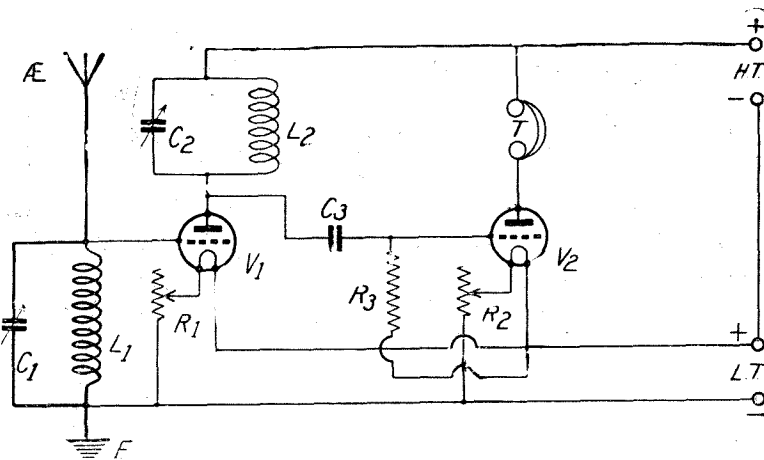

Fig. 3.—A directly coupled high frequency and detector circuit.

controls, for now we have two distinct circuits to tune. Let us however, consider the difference between Fig. 3 and 4, and see what happens. In Fig. 3 we have the well-known H.F. and detector combination directly coupled to the aerial, the inductance of which is L_1 , and the tuning condenser C_1 . It will be noted here that the negative side of the H.F. valve is earthed. Now if this circuit is well laid out and the losses in it are low, whenever the circuit C_2-L_2 is brought into resonance with the circuit C_1-L_1 there will be a great tendency to self-oscillation, particularly if the losses in the aerial circuit are small, as is often the case. With an efficient earth connection and a well-designed aerial adequately insulated, and the coils L_1 and L_2 of fairly thick wire, continuous oscillations will almost invariably be set up when these circuits are brought into tune. To check this self-oscillation and to keep it under control it is customary to introduce

losses into the first grid circuit. This can be done in several ways, one of which is to connect the lower part of L_1 not to the negative

potential on the first grid by means of a potentiometer (as is done in my "Four-valve Family Receiver"). In both of these cases stability is obtained by introducing losses into the first circuit.

Now, in the case of Fig. 4, we have a similar arrangement, but in this case loosely coupled to the aerial. Owing to the fact that the damping effect of the aerial is not directly superimposed on the grid circuit, the tendency to self-oscillation will be far greater, and unless the set is very badly designed the closed circuit L_2-C_2 and the anode circuit L_3-C_3 will break into oscillation some time before they are actually brought into tune. Considerably greater losses must be introduced here to produce stability, and this is the reason the extra selectivity obtained by loose coupling such a circuit is largely neutralised by the loss of sensitivity due to the damping

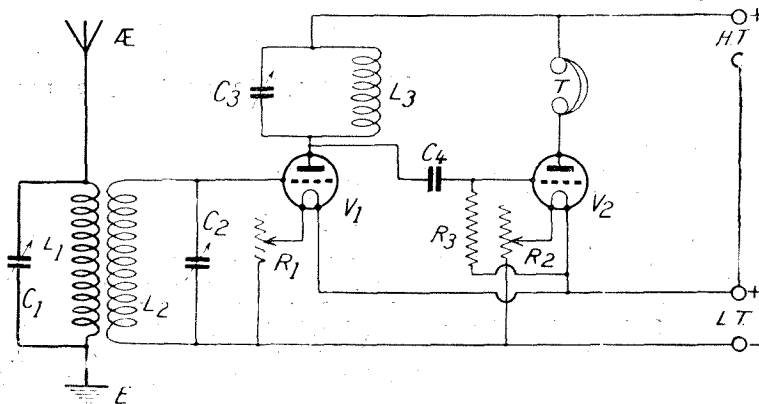

Fig. 4.—A loose-coupled modification of Fig. 3.

but to the positive side of the first valve (this is done in my well-known "All-concert" Receiver), whilst another method is to vary

needed "to hold the set down." In fact, I have no hesitation in saying that the circuit shown in Fig. 4 is not "practical."

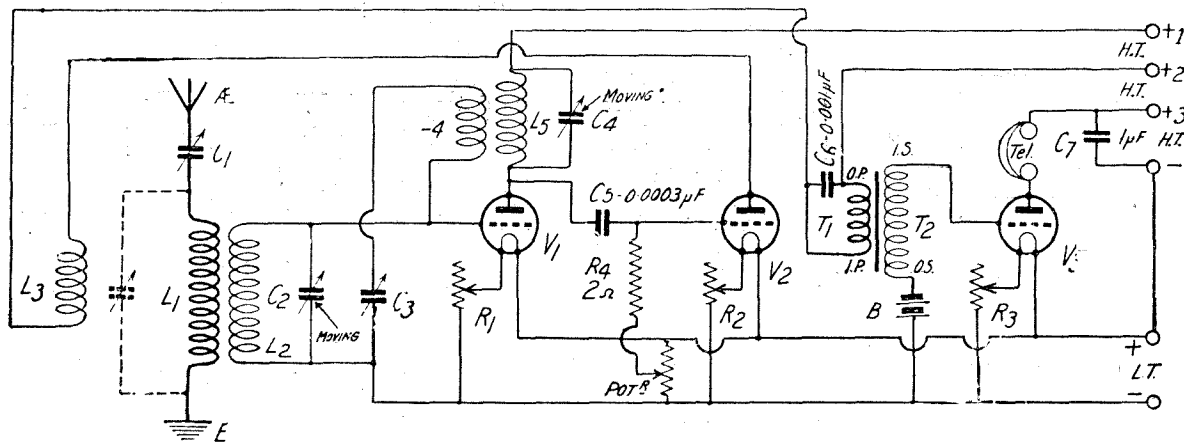

Fig. 5.—The Neutrodyne circuit used by the writer.

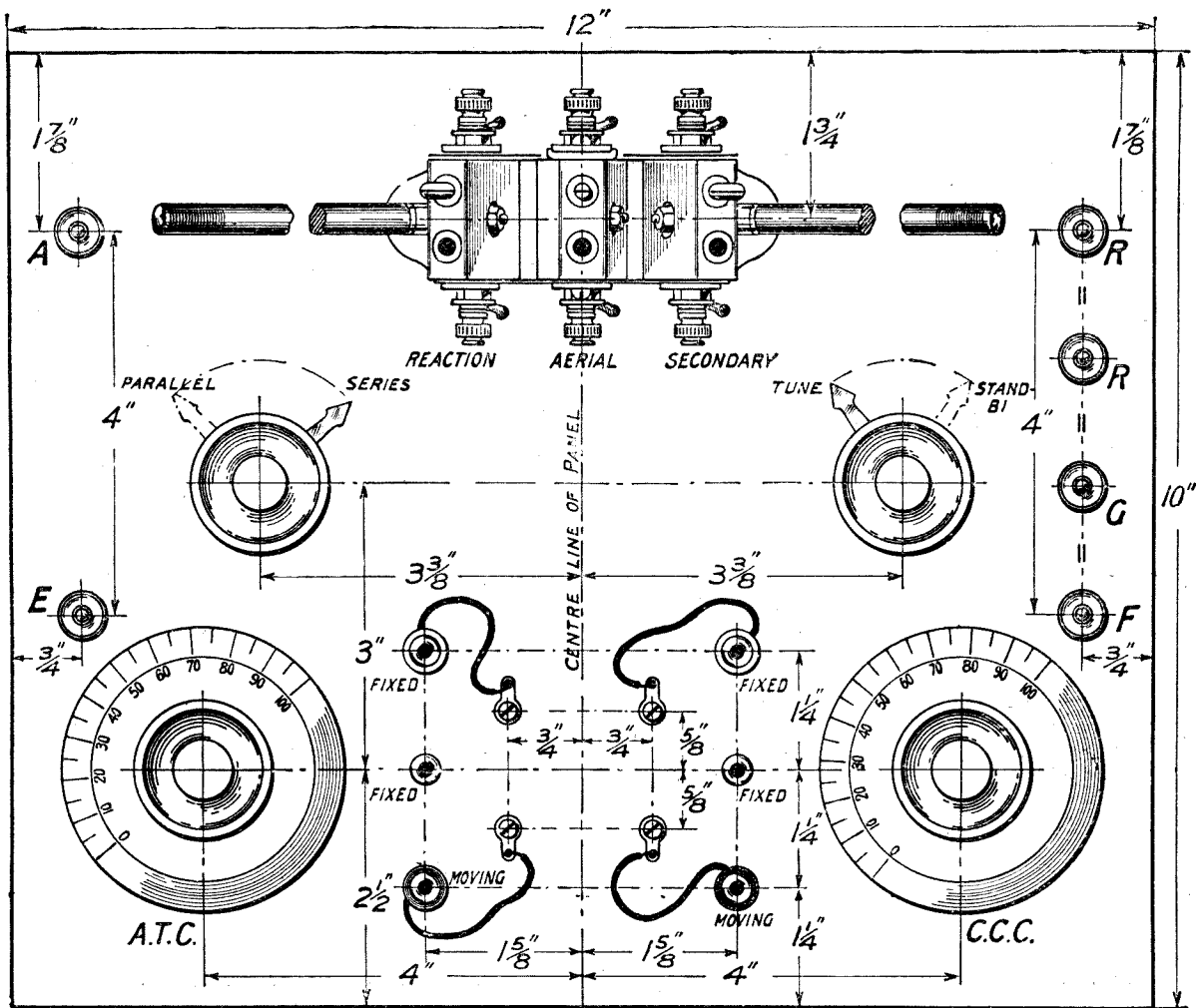

Fig. 6.—Drilling diagram of the tuning panel. In addition to the flexible leads shown, two additional links with Clix are needed.

What is the cause of self-oscillation? Every reader who understands the principle of reaction knows that if we hand back from the circuit C_3-L_3 some of the magnified energy to C_2-L_2 the oscillations of C_2-L_2 will be reinforced. The valve of course is a magnifier, and it is easy to hand back into C_2-L_2 more energy than is drawn from it. If we hand back more than we have taken away, we maintain the set in a continuous state of self-oscillation.

Now in the circuit shown in Fig. 4 there is no obvious coupling between C_3-L_3 and C_2-L_2 ; actually, however, there is a "capacity feedback," due to capacity between the electrodes of the valve and between the leads connected to it. This capacity can be considerably reduced by careful designing and by using special low-capacity valves, but whatever we do in reducing capacity in this direction we cannot entirely eliminate it.

Neutralising Methods

In the last year or two the problem of overcoming the defect has been tackled from several angles,

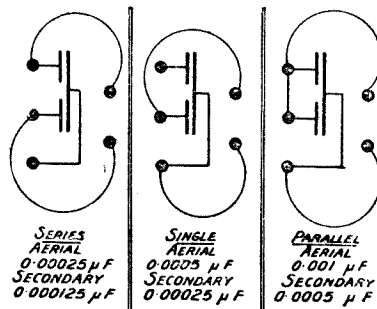

Fig. 7.—Note that in the third position a link is used between the upper two sockets.

most important contributions to the art in this direction being made by Prof. Haseltine, a well-known American expert, and by

Mr. John Scott-Taggart, F.Inst.P., in this country. The Patent Office has accorded priority in this country to Mr. Scott-Taggart for these methods, disclosed in his Patent No. 217,971. Prof. Haseltine has designed several methods of neutralising this capacity, and to one particular method has given the name "neutrodyne." Whilst, strictly speaking, the title is only applicable to the methods specified by Prof. Haseltine, any method of neutralising valve capacity has been generally called a "neutrodyne" method. One of the most practical methods I have met is due to Mr. A. D. Cowper, M.Sc.

The Cowper Method

It is the Cowper method of neutralising capacity which I have adopted, and in the present receiver I have introduced a novelty in the particular method of arranging the

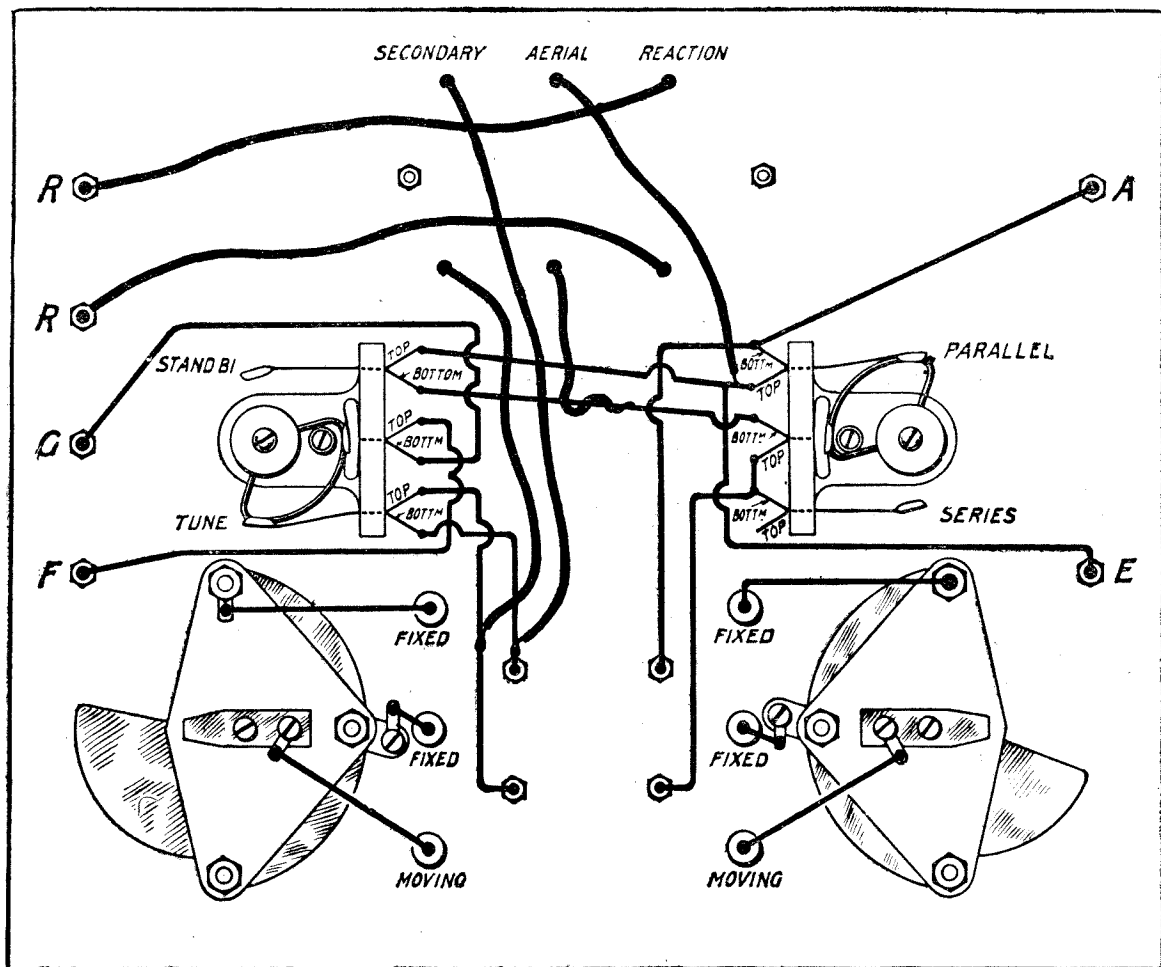
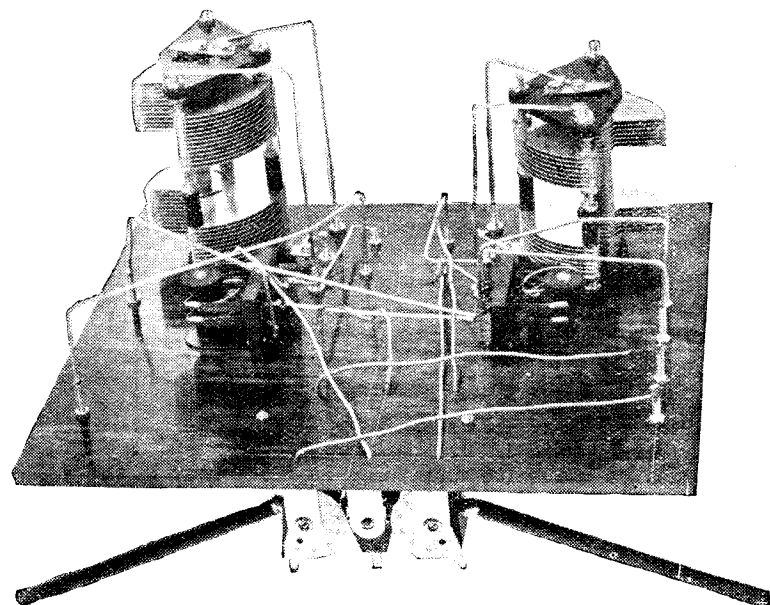

Fig. 8.—Wiring diagram of the tuner. A full-sized blueprint, No. C 1,000 B, can be obtained from the publishers, price 1/6, post free.

neutralising coil. Fig. 5 shows the circuit of the receiver in its simplest form. It will be seen that there is an aerial circuit loosely coupled to a closed circuit, which in turn is connected to a high-frequency amplifier. The high-frequency valve is coupled to the detector valve by the tuned anode method and the detector valve is transformer-coupled to a note-magnifier. In the plate circuit of the detector valve is included a reaction coil which is coupled to the aerial coil. The particular point of interest here is the neutralising coil L_4 , which must be tightly coupled to L_5 . One end of this coil is connected to the grid of the high-frequency valve, and the other to a very small condenser known as the neutrodyne condenser, which, in turn, is connected to the filament. It is not necessary here to go into the theory of the subject, this being essentially a practical article, but it may be said that the coupling between L_4 and L_5 is kept constant, and by varying the capacity of C_3 , the neutralising condenser, the

feed-back effects of the capacity of the valve can be completely neutra-

lised, leaving us a circuit in which it is possible to bring the anode



A view of the back of the tuner panel.

circuit and the grid circuit into resonance without the objectionable self-oscillation which otherwise would occur. The stability, being thus obtained by neutralising and not by introducing losses into the grid circuit, does not reduce the efficiency of the amplifier, and thus we get what we desire to have, a loosely coupled receiver, giving the benefits of selectivity and high-frequency amplification, without the usual losses. Additional amplification is obtained by the reaction coil, so that altogether we have a very efficient circuit. When I tell you that it is possible to work this set with complete stability on a wave length of 85 metres, on which I have got telephony from great distances, you will realise that my claims are not idly made.

A New Application

Mr. Cowper has described several methods of making up his circuit, his coils being specially wound for the purpose, and a Cowper neutrodyne set using plug-in coils through-

out (the coils for the anode of the neutralising inductance being in a fixed coil holder) has been described in "Wireless Weekly." This arrangement works excellently, but has the disadvantage of requiring no fewer than five plug-in coils for any given wavelength range, some of them being duplicated. It occurred to me that a very simple way out of the difficulty would be to use the well-known plug-in transformers, in this case altering the connections so that, instead of having a primary and a secondary, one could use one winding as the anode coil and the other the neutralising coil. In this way two plug-in coils are eliminated and one has only to arrange for the three coils of the tuner—that is to say, the aerial coil, the secondary coil, and the reaction coil. These three can all be different, so that the user has not to possess more than one complete set of plug-in coils in order to make use of this instrument. I am glad to say that the arrangement works excellently and just as well as with the plug-in coils.

Next month I will give some practical results obtained from this set, meanwhile we will continue the constructional part of the work.

A Tuner Novelty

In the design of this instrument I make use of a method which gives additional flexibility to the receiver. This is to make up the tuner unit on one panel and the three-valves with the associated circuits on another panel; the two being mounted, not in separate boxes, but in the same box side by side. The panels are each 12 in. by 10 in., a standard size, and the box is 24 in. by 10 in., so that when the two panels are laid side by side we get the effect of one continuous ebonite panel with four short leads connecting the two parts. If desired, the two panels can be mounted in separate boxes side by side, and some readers may prefer to do this, so as to use the loose-coupled tuner with other circuits.

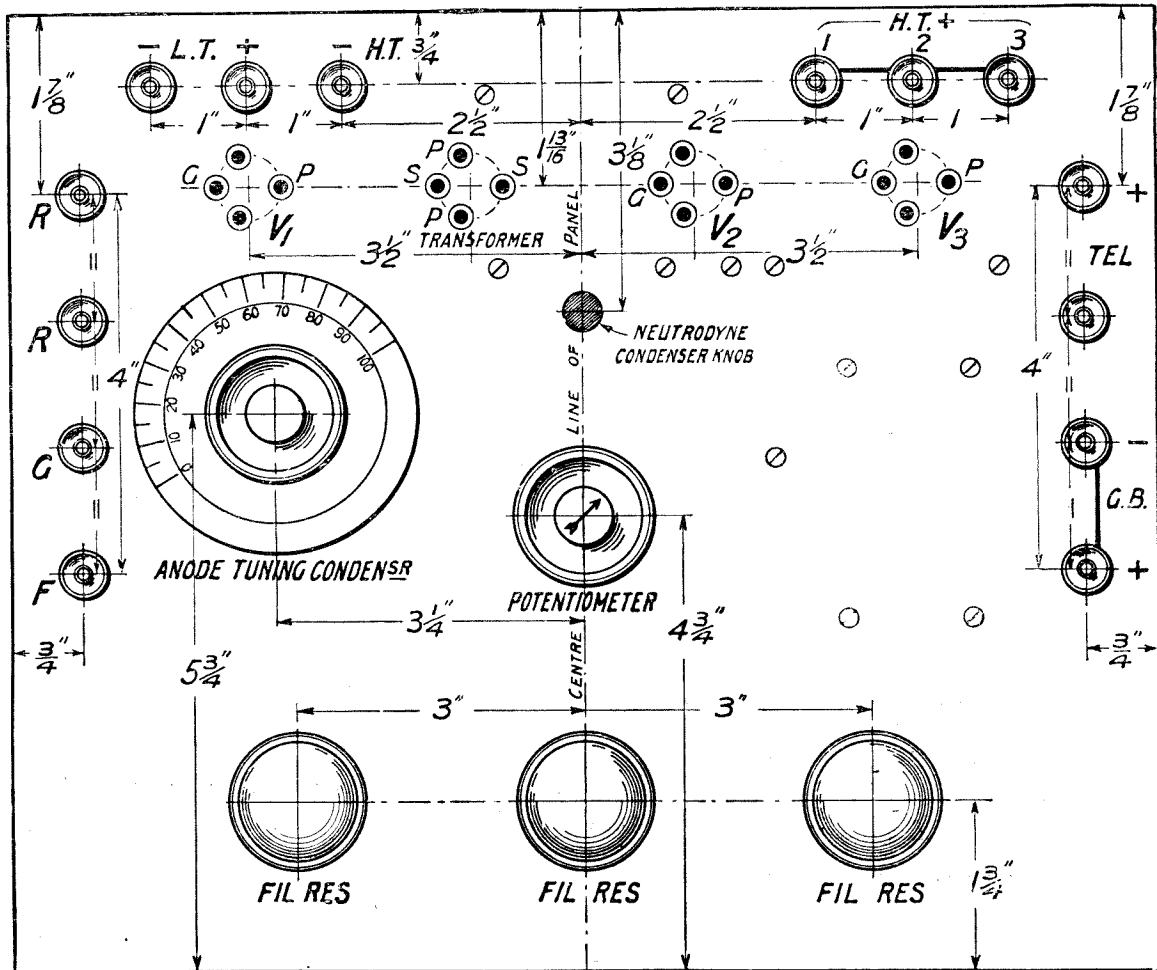

Fig. 9, Front of the three valve panel. Blueprint Nr. C 1001 A (full size) is obtainable from the Publishers. Price 1s. 6d., post free.

4 Reasons for



1 Low working temperature guarantees a longer life.

THE new Cossor Wuncell is essentially a low temperature valve. Its glow is almost invisible—certainly no brighter than the glow from a dying match. Thus long life is ensured from the commencement.

Again the Cossor Wuncell has been designed to operate from a small 2-volt accumulator. One of these of a size that will readily fit the pocket will run a 3-valve set fitted with Wuncells for a whole week's broadcasting—or a 1-valve set for three weeks—at a single charge. And the accumulator can be charged again at a cost of 9d. or less within a few hours.

While all bright emitter valves and some dull emitters operate at a temperature of at least 2,000 degrees, the Wuncell functions at 800 degrees only.

This graphic comparison proves beyond doubt why the Wuncell will easily outlast two or even three ordinary dull emitters.

Obviously its filament will never be subjected to the strains and stresses which inevitably tend to shorten the lives of valves working at a temperature nearly three times as high.

Owing to its design, its filament is quite as stout and as robust as that in the standard P1 and P2 valves. This is indeed a noteworthy achievement and disproves at once the theory that a dull emitter valve must of necessity be fragile and delicate.

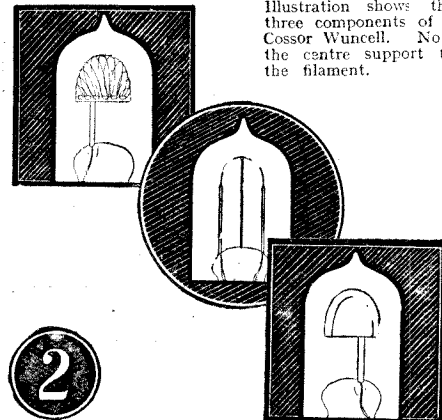

Illustration shows the three components of a Cossor Wuncell. Note the centre support to the filament.

2 Standard Cossor features ensure improved results.

ALL the exclusive features which have made the Cossor the most widely used valve in the country are retained. Its secret of success lies in the capture of practically the whole of the electron emission.

In the ordinary valve with tubular anode a considerable proportion escapes from each end of the anode without serving any useful purpose.

The arched filament of the new Cossor Wuncell is further strengthened by means of a centre support. Obviously, wireless enthusiasts will realise that in any valve the filament is the only vulnerable portion. If the filament can be so designed as to be almost unbreakable and if the valve will function when the filament is barely glowing, then the valve should have an almost indefinite life.

A further point is that the characteristics of all Wuncell valves are an exact match for the same type of valve in the Cossor bright emitter series.



Illustration showing laboratory worker taking a temperature reading by means of the Pyrometer.

This remarkable new Cossor Valve

Advertisement of A. C. Cossor, Ltd., Highbury Grove, N.5.

rapidly made by the invaluable "Clix" terminals shown in the diagram.

Tuner Switches

Two switches are provided in the tuner, one for placing the aerial tuning condenser in series or parallel, and the other for going from the "standby" to the "tune position." On "standby," the set is fairly non-selective, and does not use loose coupling. By tuning the switch over to "tune," one changes immediately to the loose coupled side, and all the advantages of enhanced selectivity may be obtained. Incidentally I should mention that when changing from "standby" to "tune," the reaction coil needs to be reversed, and it would have been possible to have a switch to do this automatically when changing over to "tune." However, this would introduce a further complication, and I feel sure that after very little practice the reader will do all of his work on the "tune" side, the reaction coil being connected the right way round for this. I am very much against complications in tuner circuits, particularly when they are

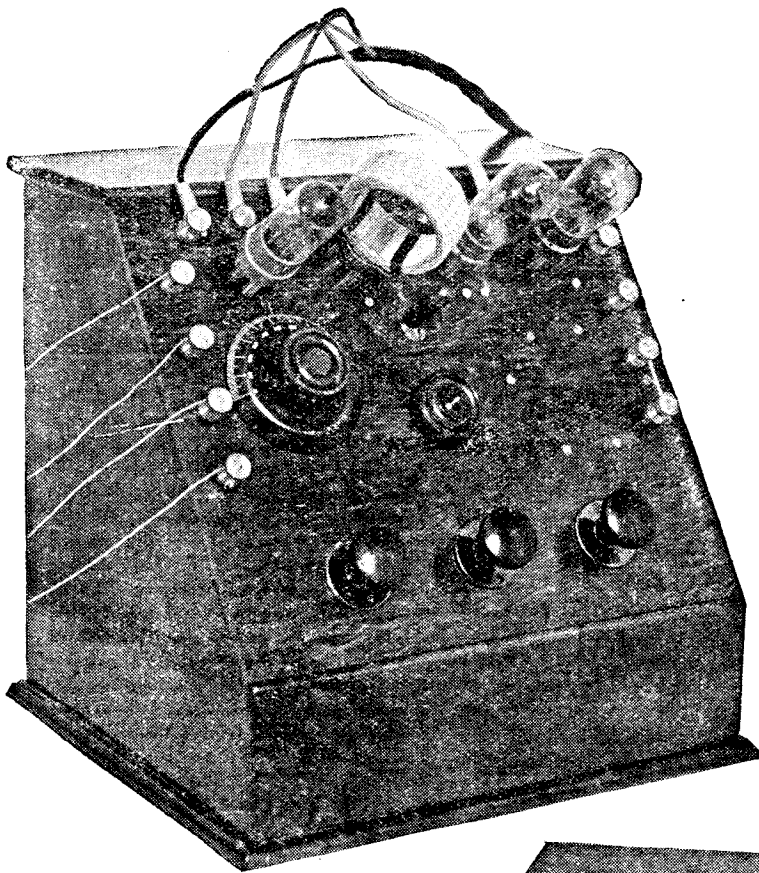

The three-valve panel in separate box.

A Tuner Novelty

Another novelty will appeal to many readers; it consists of using the now popular double condensers in a new way. Double condensers have heretofore been used almost exclusively for tuning two circuits simultaneously. But in this instance I am using them to obtain wide variations of capacity in a very simple manner. In the aerial circuit, for example, I have a double .0005 μ F. condenser. By using the two parts in series one gets a maximum of .00025 μ F., whilst by using them in parallel we get a maximum of .001 mfd. It is equally simple to use one half only, thus getting a maximum of .0005 μ F. In the secondary circuit I have a double .00025 μ F. condenser, which in the same way can give us .0005, .00025, or .000125 μ F. Thus in receiving long waves such as those above a thousand metres, it is very convenient to have .001 in the aerial and .0005 in the secondary. For very short work, as, for example, the 100 metres American telephony, we can have .0005 in the aerial and .000125 in the closed circuit. To avoid complicated switching, the changes are

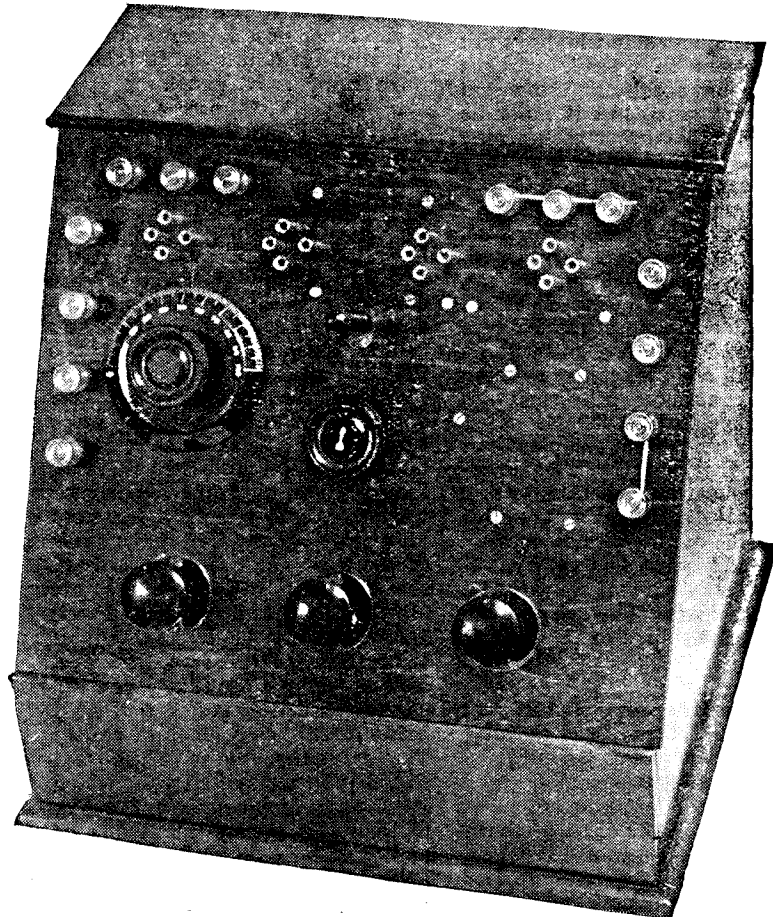

Valves and transformer removed.

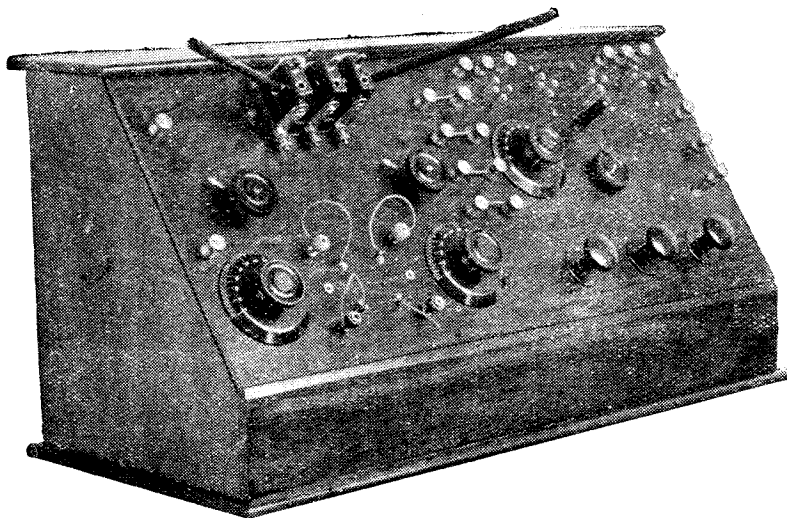

The two panels side by side in one cabinet.

to be used for short waves; and after all it is quite a simple matter to reverse the flexible leads between the reaction terminals on the tuner and those on the valve panel. This should be done when changing over.

Tuner Components Needed

For the tuner the following components are needed. As it may interest some readers who have not ready access to reliable wireless dealers, I am specifying the actual components used, but it must be understood that other makes may be used if desired, so long as they are of good quality.

- 1 panel, 12 in. by 10 in. (I have used Radion Mahoganite here. This is a first-class ebonite resembling polished mahogany, supplied with a polished surface guaranteed free from any leakage. It should be used exactly as received, and in fact any rubbing of the surface will spoil its appearance. If you use other ebonite (and there are plenty of good makes) buy either a guaranteed leakage-free ebonite, or else make quite sure that you remove every bit of the surface skin on both sides with fine emery. If you do not do this there will be a serious danger of leakage and you may get all kinds of bad effects which you may not attribute to this cause.)
- 2 double-pole two-way change-over anti-capacity switches. (Utility, made by Wilkins & Wright.)
- 1 three-coil holder (Igranic).
- 1 double condenser .0005 μ F.
- 1 double condenser .0025 μ F. (both of these condensers are Bowyer-Lower square law. Square law condensers are now made by

several firms and I strongly recommend their use.)

- 6 terminals 4BA.
- 6 "Clix" sockets.
- 8 "Clix" plugs.

About 2 ft. of flexible indiarubber covered wire (single electric lighting flex will do).

No. 16 square wire for wiring up.

And, finally, if you intend to keep the tuner in a separate box, one box about 6 in. deep to take the 12 in. by 10 in. panel.

Building the Tuner

I do not think any special instructions are needed on the manner of assembling the tuner, for the drawings will show quite clearly how to connect up the parts. Several makers of variable condensers now supply drilling templates, which are of a great help in drilling holes for the screws. See that you mark out your panel very carefully, for nothing spoils the appearance of an instrument more than holes which have been drilled in wrong places and then filled in. As a guide to the home constructor we are able to supply a full-sized blue print of the front of the panel of the tuner, and also of the back showing the wiring. These are obtainable from Radio Press, Limited, Bush House, Strand, at the price of 1s. 6d. each, post free. You should ask for Blue Print No. CroooA (front of panel) and Blue Print No. CroooB (back of panel). The reproductions in Fig. 6 and Fig. 8 are exactly half size, which itself may prove sufficient guide. However, so many thousands of blue prints have been sold since I first introduced them in "Modern Wireless," that I cannot help

feeling that most constructors find them a great help.

Valve panel parts

When you have built your tuner you will naturally desire to proceed with the valve panel. Here are the parts required for this instrument.

- 1 panel 12 in. by 10 in. (Radion mahoganite or other good ebonite as previously stipulated).
 - 14 terminals.
 - 4 sets of valve sockets (low-capacity type are recommended).
- (Notice that FOUR and not three sets are required, as one set is needed for the plug-in transformer.)
- 1 .0002 to .003 μ F variable condenser (Bowyer-Lower square law).

(The value of this condenser can be .0002, .00025 or .0003 μ F. I have used .00025 μ F.)

- 1 Neutrodyne condenser (Gambrell Brothers.)
- 1 potentiometer (Ediswan).
- 1 low-frequency intervalve transformer (Radio Instruments).
- 1 fixed condenser .001 μ F (Dubilier)
- 1 " " " .0003 μ F " "
- 1 grid leak 2 megohms (Dubilier.)
- 1 Mansbridge condenser 1 μ F (T.C.C.).
- 1 or more plug-in H.F. transformers (according to range of wavelength required).

(When used in this special manner the wavelength ranges will still be approximately those described on the transformers).

- 3 filament resistances (for bright or for dull emitters according to desire of the user. I have used the Burndept Dual resistances as these can be used with either bright or dull emitters at will).
- 1 box to take the 12 in. by 10 in. panel, 6 in. deep.

The Cabinet

If, however as I recommend, you have one cabinet to take the two panels, then the sloping front type can be used and the two panels could fit side by side in the cabinet made 24 in. by 10 in. I have personally used a cabinet made by The Carrington Manufacturing Company. It is of polished mahogany and has the advantage of a sliding back so that the wiring can be examined without the need of taking the panel from the front. There are several good firms manufacturing wireless cabinets.

Construction of the Valve Panel

If you examine the front of the valve panel you will see that

There are four terminals arranged to correspond with the right hand terminals of the tuner panel. There are six terminals at the top. Reading from the left they are for the low-tension negative, low-tension positive, high-tension negative and then on the right three separate high-tension positives. The first high-tension positive is for the high-frequency valve, the second is for the detector valve and the third for the low-frequency valve. The beginner can connect all three of these together using one valve of high-tension, but the experienced will know that better results are obtained by using different potentials on the three valves. On the right hand side of the panels are four terminals, the upper two being for telephones or loudspeaker, the lower being for the grid bias for the last valve. Again the beginner can, if desired, connect the grid bias terminals together, while the experienced man will introduce the requisite cells to give the best results when using a high-potential on the last valve.

Use of the Potentiometer

A small refinement I have introduced into this set is the use of a potentiometer in connection with the grid leak. I have taken the lower side of the grid leak to the slider of a potentiometer. In this way it is possible to use the grid leak on either the negative, the positive or any intermediate position. In most cases it will be found best when the slider is right over on the positive side.

Constructional Work

The constructional work in this receiver is not difficult, and as we are giving a free blue print of the back of panel wiring of this unit the reader will be able to commence as soon as he has collected his component parts. The remarks I made previously regarding the ebonite being free from surface leakage apply just as strongly to this panel (more so in fact) than they do to the tuner panel.

The very important point in this unit is the neutralising condenser. Do not imagine that any single plate vernier will do. The Gambrell Neutrodyne Condenser has been specially designed for neutrodyne circuits; but beyond

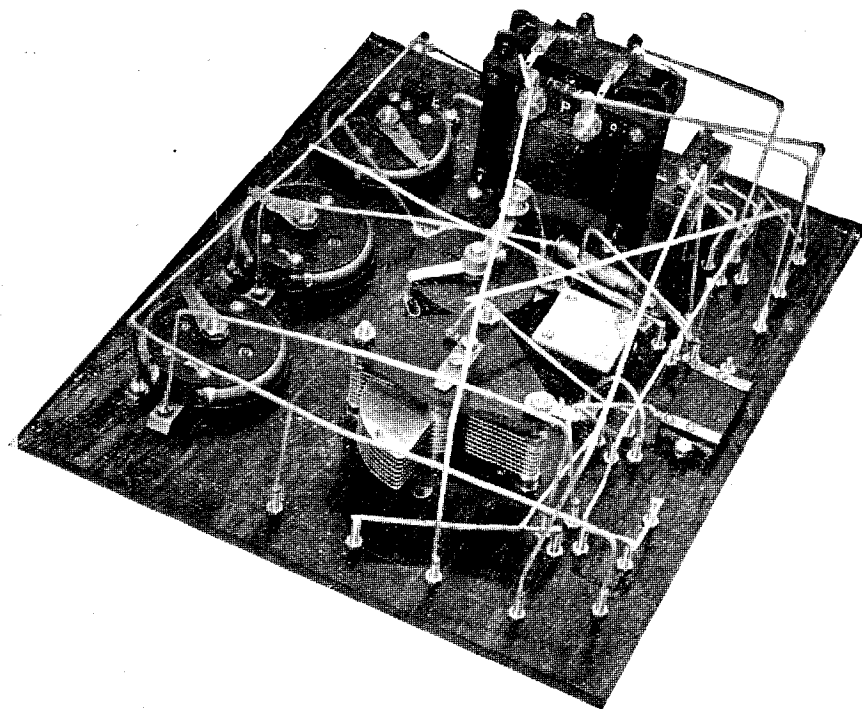

Back of the three-valve panel.

this I know of no other ready-made condenser at the present time.

Watch the Layout

In assembling your parts follow as closely as possible the layout given. It is not that I claim it is the best layout conceivable, but it is a layout that works well—the most powerful argument I know! Notice that the I.S. of the Radio Instruments transformer is connected to the grid, not O.S. as is often done. I have spent some time recently testing transformers and find that this particular make works best when the I.S. is connected to the grid, and the makers confirm this. Other makes of transformers may work well with either I.S. or O.S. connected to the grid, and if you do not use Radio Instruments I advise you to try out which is the better way round. There is no hard and fast rule in this matter of connecting I.S. and O.S., though in the majority of cases O.S. is found to be better.

The .001 μ F condenser connected across the primary of the intervalve transformer can be laid on the back of the transformer and the soldered stiff wire coming to it will hold it in place. Be sure in joining up the potentiometer that the bottom end of the grid goes to the slider. If you are using an Ediswan potentiometer the slider connection is that on the side away from the panel.

Connecting Up

When you have finished the wiring of this panel, you can place the two panels side by side in the cabinet, or if you are using separate boxes, bring the two boxes together with their panels in place, and connect the four terminals on the right of the tuner panel to the corresponding terminals on the valve panel. Do not yet connect aerial and earth, and for safety sake turn the filament resistances to the "off" position. Now connect up your accumulator to the L.T. terminals. Try each valve filament resistance in turn with valve in place. In the first socket I recommend one which is good for high-frequency amplification, while for the detector any of the good general purposes valves will do. In the note magnifier, you have a wide choice. A general purpose valve will serve excellently, but you will get still better results if you use one of the special note-magnifying valves available. When you have tested all three filament resistances and they function satisfactorily and the valves light, connect up the high-tension battery, and you can begin work.

NEXT MONTH:
*How to Use this
Interesting Receiver.*

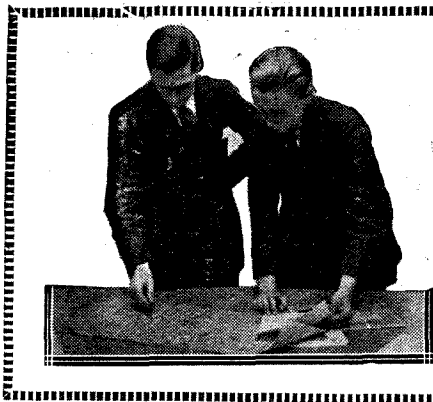

How to read a Wireless Circuit Diagram

By E. Redpath.

Removing one of the initial difficulties encountered by the would-be wireless enthusiast.

IT has been said of golf that it is not only a game, but a language. The same remark may surely be applied to the greatest of all modern "games"—wireless, at all events by the beginner finding himself for the first time in a circle where the subject is under discussion.

Not only are many unfamiliar words employed, but, at intervals, peculiar signs and symbols are hastily sketched upon paper and apparently afford a complete and satisfactory explanation of the point at issue, although to the uninitiated they appear so much Greek or shorthand.

Wireless Shorthand

The latter is exactly what the symbols are—wireless shorthand, universally adopted as a means of illustrating, clearly and readily, the components which go to make up a wireless transmitting or receiving set, and at the same time showing how they are to be connected together in order to produce the desired effect.

Naturally, in order to progress, the beginner must learn to interpret the various symbols. That is to say, he must learn to read circuit diagrams as he would straightforward letterpress. To some, this may sound difficult, but it is not so in reality, and it is hoped that this little article, with the rather novel circuit diagrams and pictorial illustrations of components alongside the symbols which represent them, will prove of assistance.

A Crystal Set

The first diagram represents an inductively coupled crystal receiver. In such a comparatively simple diagram the separate circuits which form the complete receiver are easily identified. There are three circuits, namely: the aerial, secondary or closed oscillatory, and the detector circuit.

The aerial itself, of whatever type actually, is indicated by the symbol at \mathcal{A} . The aerial-tuning

condenser (of variable capacity as indicated by the arrow drawn across at an angle) is shown at C_p in the parallel position and, in dotted lines, at C_s in the series position, whilst the aerial-tuning inductance and earth connection are shown at L and E , respectively.

The Secondary Circuit

The secondary circuit comprises the secondary-tuning inductance L_1 and the variable condenser C_1 , the latter being connected in parallel

C_2 connected (sometimes termed "shunted") across them.

Showing Joints

The various connecting wires are clearly shown and easily followed. Those wires which are joined together have a distinctive dot at their junction, whilst wires which merely cross one another in a diagram but are *not* connected may be recognised by the "looping" of one line over the other.

Actual components of a receiving

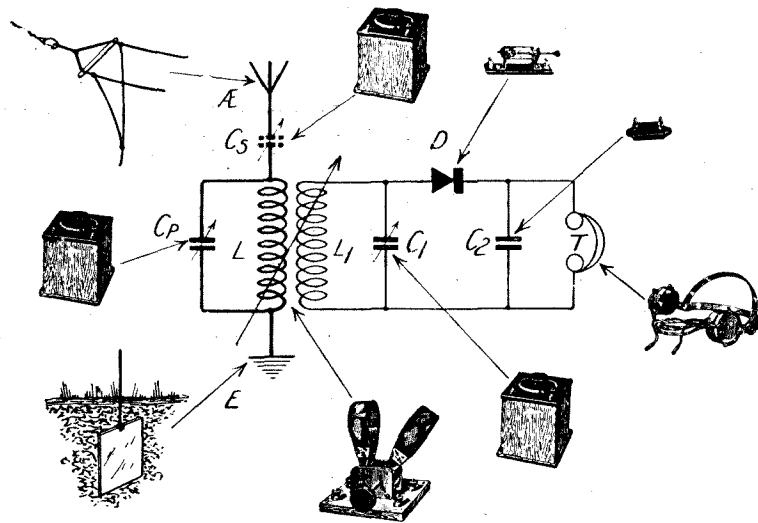

Fig. 1.—An inductively coupled crystal set explained.

with L_1 . The arrow drawn through the two coils L and L_1 indicates that their relative position may be altered. Either or both coils may be movable and the effect of altering the angle between them is to vary the electro-magnetic coupling. The arrow therefore indicates a variable coupling, and in all diagrams may be taken to indicate variability of the component represented.

The remaining circuit is the detector circuit comprising the crystal detector D , telephone receivers T with fixed condenser

set will, of course, be provided with terminals and, in the case of the aerial circuit in the above diagram, where the upper end of the aerial tuning inductance and one side of the variable condenser are *connected directly together*, it is immaterial whether the aerial lead is attached to the terminal on the inductance or condenser.

A More Complex Diagram

Fig. 2, although a slightly more complex diagram than Fig. 1, may readily be resolved into its several separate circuits whilst, as in the

previous case, pictorial representations of the various symbols are given, thus rendering further interpretation unnecessary.

The diagram (Fig. 2) represents a two-valve receiver, the first valve functioning as a rectifier (detector) and the second as a low-frequency amplifier. Incidentally, the arrangement shown makes a very serviceable receiving set.

Reaction

The provision of reaction from the anode of the first valve on to the aerial circuit improves the sensitivity considerably, whilst the second valve will give good magnification of all signals which are strong enough to actuate the first valve. However, at the moment, it is not so much a question of the scope or utility of the arrangement indicated as of learning how to interpret the diagram correctly.

Several of the symbols will be recognised immediately as having occurred in Fig. 1. For instance, the inductances L , L_1 , and the variable condensers. The valves, V_1, V_2 , each with its three electrodes, anode, grid and filament, and the connections thereto, will not be found to present any great difficulty if it is always borne in mind that, however complex the arrangement, the actual circuits for each valve will *always* be three in number, namely—the filament lighting circuit, the "input" or grid circuit, and the "output" or anode circuit.

This point will be best appreciated by tracing out the various circuits upon the diagram as they are described. Take the filament lighting circuits first. Each valve is provided with a rheostat (or variable resistance) R, R , to control the amount of current flowing and consequently the temperature of each filament, and the complete filament circuit of each valve includes the six-volt accumulator B_1 ; rheostat R and the filament

itself, these items being all in direct metallic connection, as indicated by the connecting lines in the diagram.

The Aerial Circuit

The aerial circuit comprises the aerial itself, \mathcal{A} , the inductance coil L with parallel variable condenser C , and the earth connection E . The inductance L is also common to the grid-filament or

indicated by the arrow through the two coils); the primary winding T_1 of the iron-core transformer T_1, T_2 with by-pass condenser C_2 ; the high-tension or anode battery B_2 , the positive terminal of which is *always* connected to the anode of the valve via the intervening components, and the filament connection.

The letters IP and OP indicate the inner and outer ends,

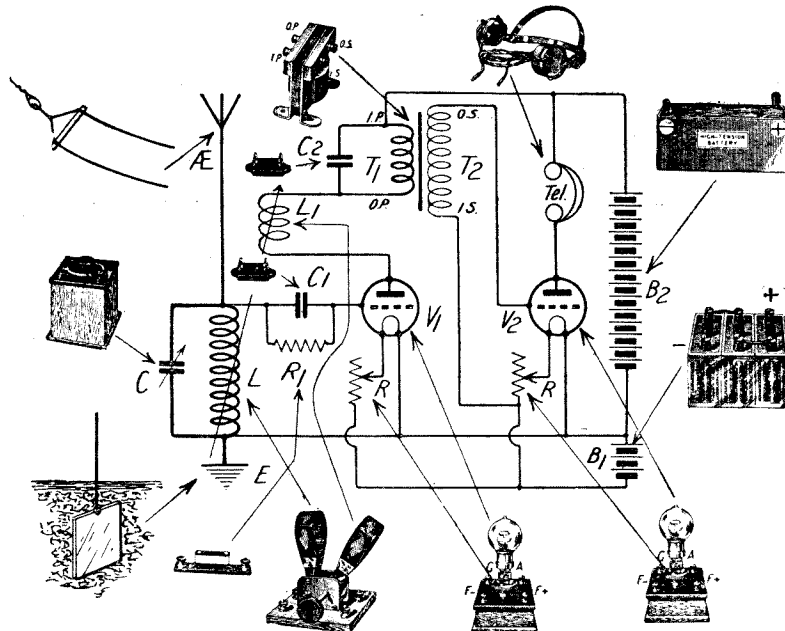

Fig. 2.—A two-valve set shown in picture and diagram.

input circuit of the first valve, which comprises the grid itself, grid-condenser C_1 (a small one of fixed value) shunted by the grid-leak R_1 (a resistance of about two million ohms—two megohms), the inductance L , and the connection to the positive side of the filament or the accumulator.

The output or anode circuit of this valve includes the anode itself; the reaction coil L_1 (variably coupled to the inductance L as

respectively, of the primary winding of the transformer, IS and OS having a similar significance in the case of the secondary winding.

The secondary T_2 of the iron-core transformer, and connections to grid and negative side of filament, form the input or grid circuit of the second valve V_2 , in the anode or output circuit of which are connected the telephone receivers Tel.

OH! HECTOR!! No. 1.

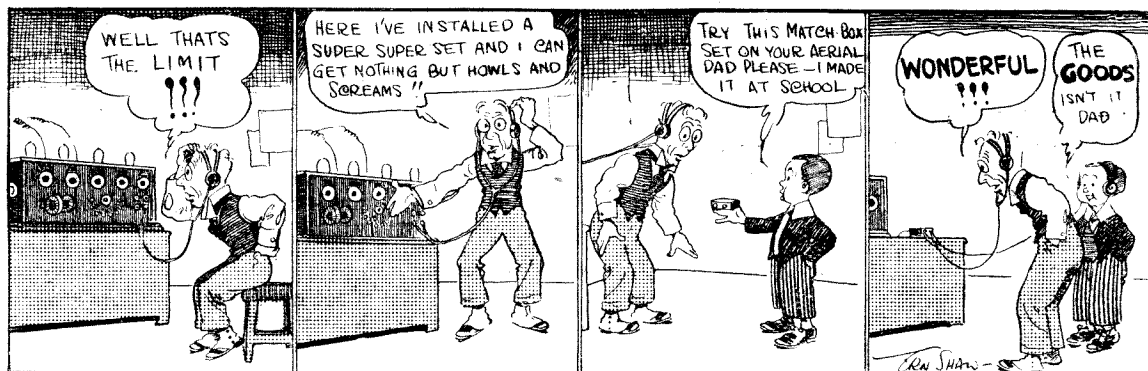

If you have not felt like this yet, you will some day!



THERE must be many who will read these lines who will be gaining their first impressions of a Radio Press periodical from this new magazine, strange as it may seem to those to whom Radio Press books and periodicals are old and well-tried friends. It is in the hope of bringing such new readers to some appreciation of all the manifold services which the Radio Press is prepared to perform for them that this article is being written, and old readers of our productions are asked to exercise forbearance in reading such sections of this contribution as cover ground which is already familiar to them. They will, notwithstanding, find much to interest them concerning our new developments.

At the very outset we must emphasise the *comprehensiveness* of the Radio Press Service to the wireless enthusiast, and we use the word "service" advisedly, since it forms the keynote of the Radio Press policy. We are here to serve the interest of our readers in every conceivable manner, and our watchwords are accuracy and dependability. It would be easier to enumerate the things which we *cannot* do for the reader than to give a full account of all the different ways in which we can reader assistance, but the following notes will perhaps give some broad outline of our service.

Periodicals

In addition to the journal which you are now reading, Radio Press publishes two periodicals which are indeed the proverbial household word in the world of wireless. There is the weekly journal, *Wireless Weekly*, which is the periodical above all others which no enthusiast of experimental tastes can afford to miss, forming as it does a most indispensable record of all the latest

wireless news and developments. Edited and produced by the well-known Radio Press technical staff, it enjoys in point of reputation a quite unrivalled position.

Appealing to constructor, experimenter and broadcast listener alike, *Modern Wireless*, the Radio Press monthly magazine, with its wealth of theoretical, constructional and general articles, forms the periodical which every wireless man feels that he *must* read.

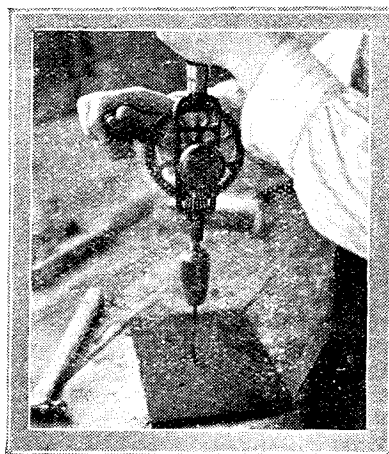

Radio Press, Ltd., has the confidence of every home constructor in the country.

Books

The real wireless enthusiast is never content to miss one of the greatest fascinations of his hobby, namely, the comprehension of how it all works, and here the Radio Press service is wonderfully full and complete. A great range of books is published, now over 20 in number, and from amongst these one can select the volume to cover almost every conceivable need.

Radio Press Envelopes

Of all the Radio Press publications probably the Envelopes have achieved the greatest popularity with home constructors, who have found them to provide the ideal source of instructions for the building of sets.

The Radio Press Service Department, Ltd.

Last, but by no means least, we have the separate organisation which has been specially formed to deal with individual readers' difficulties. This organisation forms a most essential support for the Radio Press policy of the utter dependability of all its set designs, since it provides the means whereby any reader who is so unfortunate as to build one of our sets and fails to get good reception, as a result possibly of some trifling mistake in construction or the use of a defective component, can be put upon the right track and helped on to success. The Service Department is divided into two sections, one being the Test Department, which deals with all questions of the determination of the cause of poor results in any receiver, the other being the general Queries Department, which conducts the postal query service and gives personal advice to callers in special cases.

Our Own Designs

The Test Department deals only with receivers which have been made up with fair accuracy from Radio Press designs by a reader himself. That is to say, they cannot undertake to deal with receivers made up from other designs or sets which have been made up from Radio Press designs by a commercial undertaking. Similarly, if a set has been made up with very heavy deviations indeed from the original Radio Press design, no responsibility can be accepted for the quality of the results obtained,

and the Test Department may at their discretion decline to undertake to investigate the cause of the poor results. We have been compelled to institute this regulation as a result of the wide experience which we have had of the troubles which result from the modification of our designs. Of course, if the modification is only slight we will

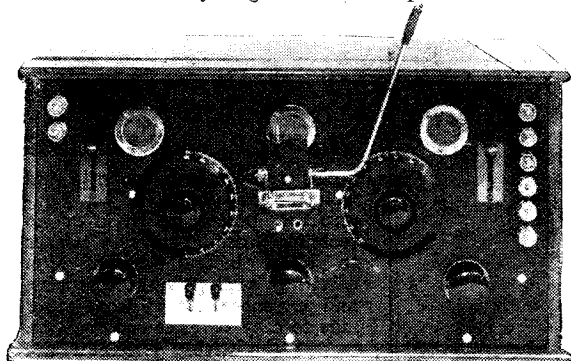

Radio Press Envelope No. 4.
"The All-Concert-de-Luxe."

deal with the set, but an extra charge of 25 per cent. upon the ordinary test fee may be imposed at the discretion of the department.

Our Object

The whole object of the Radio Press Service Department is to assist our readers in their difficulties, and to help them to realise that when they undertake to build a Radio Press receiver they can be absolutely certain of final success if they will follow the design accurately. We therefore only aim at covering our own expenses, and a standard fee for the testing of valve sets of 2s. 6d. per valve has been fixed. Dual valves are counted as two, so that the fee for, say, the ST100 receiver is 7s. 6d., while there is a minimum of 3s. 6d. for a single-valve set. Crystal sets are tested at a charge of 2s. 6d., and single simple components such as a fixed condenser can be dealt with as a rule for a fee of 1s.

Low Fees

These fees cover simply the thorough testing of the receiver, both in all its components and as a complete instrument, including a test upon aerial when the set is in a fit condition, and the furnishing of a detailed report thereon. It does not cover the making of alterations for the purpose of putting the set into working order, and the usual procedure is to return the set, pointing out the faults to the owner, and leaving him to make the necessary rectification. Under special circumstances, we can undertake to make small alterations

when readers desire it, such work being quoted for separately. Readers, of course, pay carriage upon their sets in both directions when they are sent in to us from a distance, and no responsibility is accepted by the department for the safe custody of the sets while in our hands, although every possible care is taken of them. Those who wish to bring the sets in personally will find the Receiving Department for the testing work situated in No. 2, Melbourne Place, Aldwych, W.C.2, which is located between Australia House and Bush House. This is a temporary address and will probably be changed in the near future, due notice to be given.

Postal Queries

The Postal Queries Department is intended to deal with more general difficulties, and to supply any kind of wireless information, and the extent of its activities necessitates the maintaining of a considerable skilled staff, with consequent heavy expense to ourselves. It has therefore been found necessary to impose a fee for the answering of postal queries of 2s. 6d., which may seem a great deal to those who have never found themselves in need in an emergency of expert advice, yet scores of our readers take advantage of this service every week, and find it well worth their while to obtain really dependable advice. Readers who invoke the aid of this branch of the department are requested to enclose a stamped self-addressed envelope with their letter, to write distinctly upon one side of the paper only, and to make their letters as brief and to the point as possible. Of course, the fullest essential details should be given regarding their own particular difficulty.

A Few Exceptions

The Postal Queries Department can deal with any specific wireless matter, with certain exceptions,

and it is perhaps as well to state definitely the few things which we cannot do. In the first place, our independent editorial position does not permit us to give advice as to the best kind of valves to use, and so on, or in any way to express a preference as to commercial apparatus. We cannot enter into correspondence upon matters of technical advice with members of the wireless industry, or undertake to carry out the usual functions of the Department on their behalf, since the Department is intended solely for the benefit of our readers. Limitations of time and the heavy expense involved make it impossible for us to give elaborate wiring diagrams, or complete sets of instructions for building apparatus; but apart from these limitations our readers will find that no problem is too troublesome for us to solve in their interests.

New readers will, no doubt, be interested to learn that the Exhibition of the Radio Press sets is also located in the Service Department premises. Every set described in one of our magazines is on exhibition here for a period of 21 days, during which any interested reader may inspect them for himself, while the Radio Press envelope receivers are on view permanently.

The Radio Press aerial may be seen high up above Bush House, the magnificent business building in which the Radio Press organisation is housed. The Radio Press Information Department offices are temporarily in the wooden building

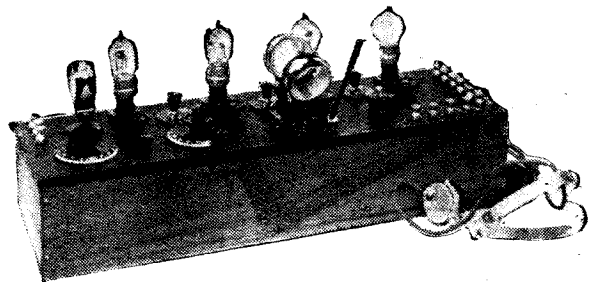

Radio Press Envelope No. 2.
"The Four-Valve Family Set."

between Bush House and Australia House, in the Strand.

It will thus be seen that Radio Press, Ltd., the largest wireless publishers in the world, are wireless publishers *only*, and do not dissipate their energies in any other direction. Readers are thus assured of the finest possible technical service, competently supervised in every department of the business.

Just out!

A wonderful new system of simplified wireless construction

As the Pioneer Publishers of Wireless literature, THE WIRELESS PRESS can claim another noteworthy achievement in the publication of this splendid "EZI-WIRING" series.

2/- EACH

ON SALE EVERYWHERE
POST FREE 2/2



WIRELESS PRESS

The W.P. EZI-WIRING

Series represents a definite and welcome innovation for the Constructor, possessing little or no technical knowledge, who wishes to build instruments of high efficiency with minimum trouble and expense. Apart from other aids to easy wireless construction the wiring diagrams are shown in four colours—a unique feature which prevents any possibility of incorrect wiring by rendering this frequent cause of difficulty a matter

The W.P. EZI-WIRING Series

- No. 1. A 3-Valve Portable Receiver by HUGH S. POCOCK.
- No. 2. A 3-Valve Receiver by F. H. HAYNES.
- No. 3. A 2-Valve and Crystal Reflex Receiver by W. JAMES.

of extreme simplicity. In addition, there are explanations, progressive diagrams and plates showing the Set concerned in various positions with the disposition of the components—in fact every item is adequately dealt with which can possibly facilitate accurate, speedy and faultless construction, however limited the Amateur's knowledge. There are no loose sheets. Detailed measurements are given, particulars as to the size and use of the various parts, as well as full instruction on the operation of the completed set.

Issued by
THE WIRELESS PRESS LTD., 12-13 HENRIETTA STREET, LONDON W.C.2.

Oh it is excellent to have a giant's strength"

AT LAST a giant valve

—a valve with giant strength, giant results and giant life, but still the same neat convenient size.

You will appreciate the unique design of the Mullard Grid. Its undercurving convolutions permit of no downward escape of your valuable electron emission. You can get this Master Valve in two specialised designs.

MULLARD H.F. Red Ring Valve for high-frequency amplification or detection 12/6
MULLARD L.F. Green Ring Valve for low frequency amplification 12/6

Write for leaflet V.R. 18.

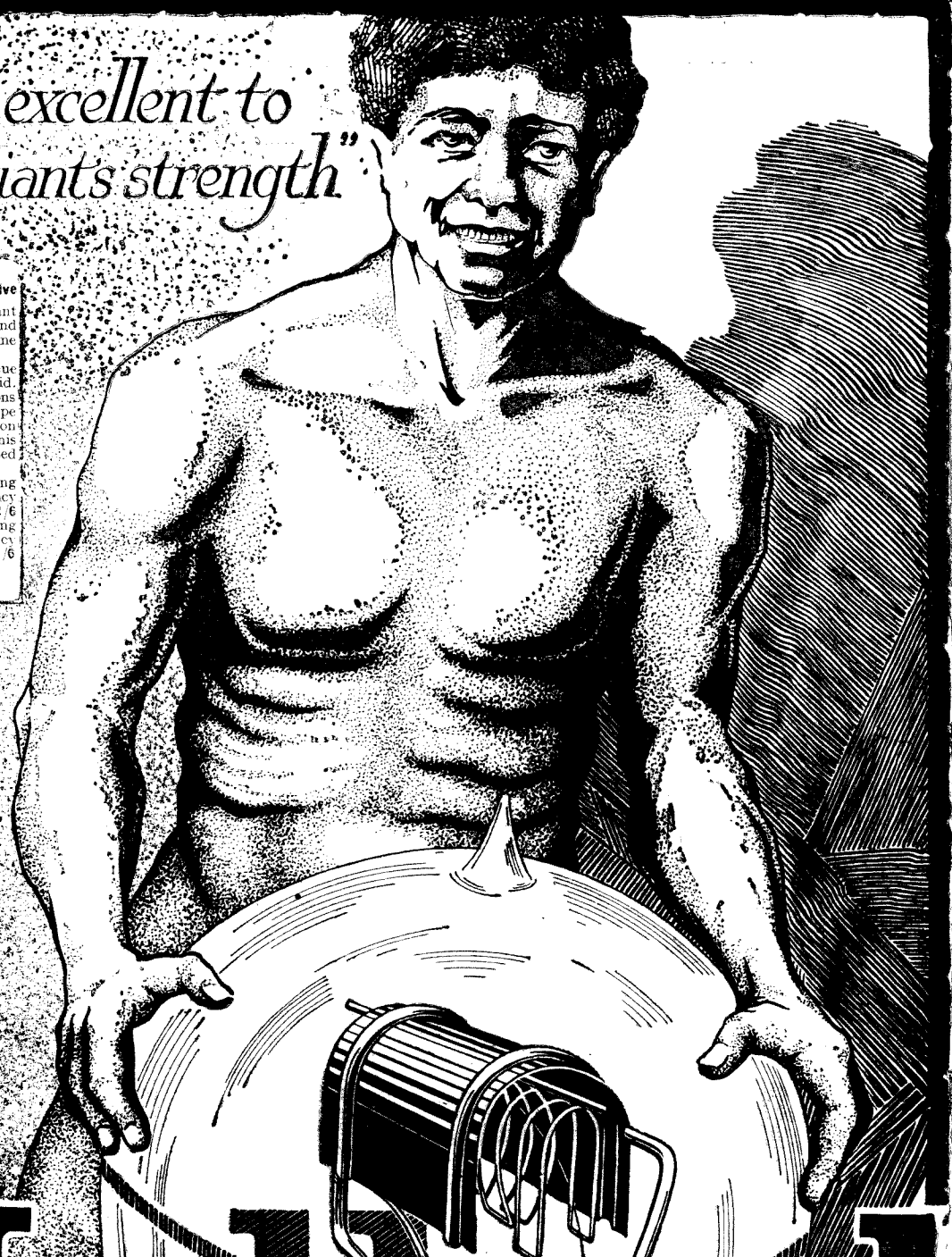

MULLARD

THE MASTER VALVE

Advertisement of the Mullard Radio Valve Co., Ltd. (T.W.C.), Nightingale Works, Nightingale Lane, Balham, S.W.12.

In replying to advertisers, please mention THE WIRELESS CONSTRUCTOR,

A Picture Guide to Basket Coil Winding

By G. P. KENDALL, B.Sc.

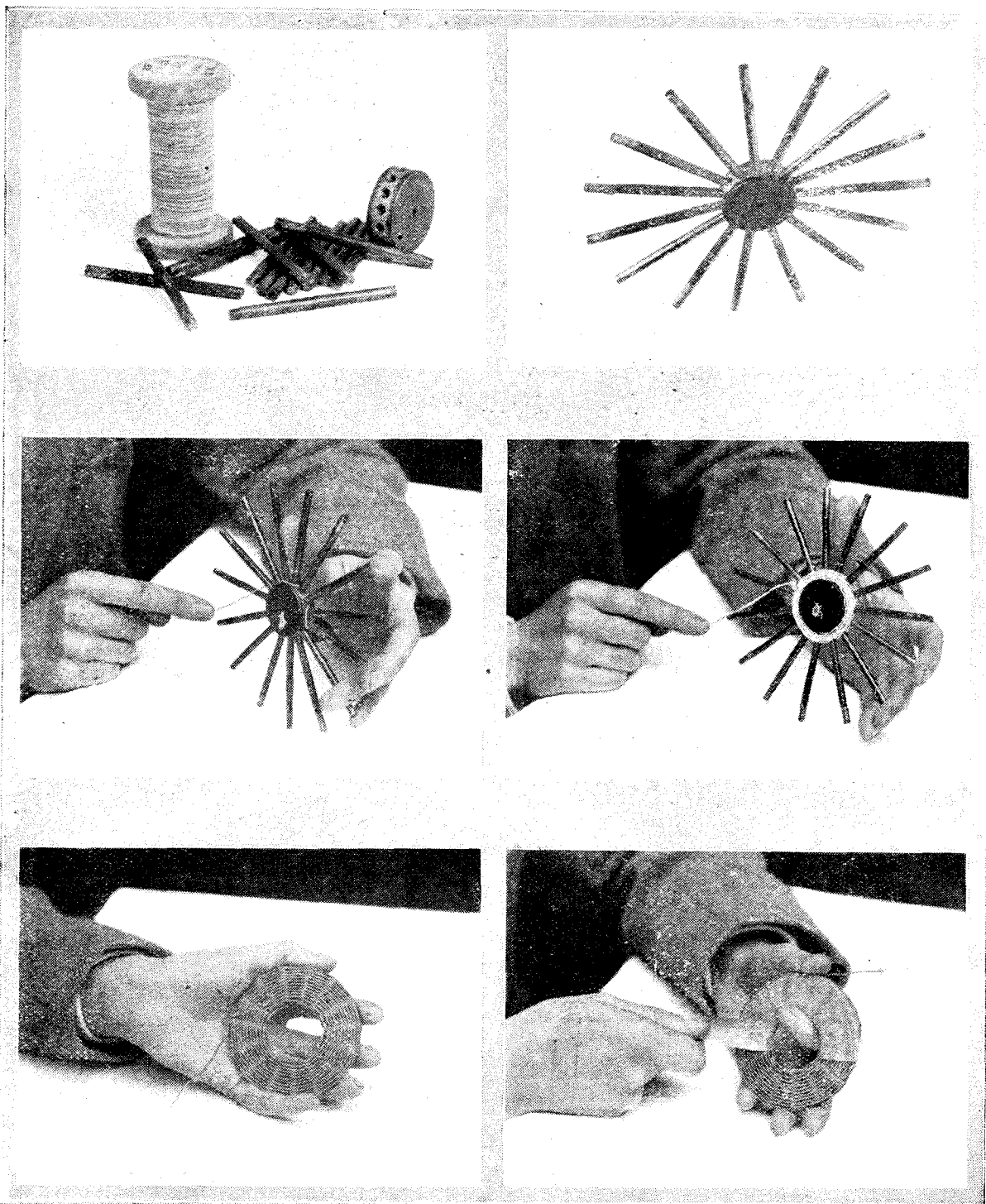

Fig. 1.—Ready to begin.

Fig. 3.—Starting a coil.

Fig. 5.—Coil removed from former and varnished

Fig. 2.—The basket coil former with pegs in place.

Fig. 4.—After a few turns.

Fig. 6.—Taping the coil after varnishing.

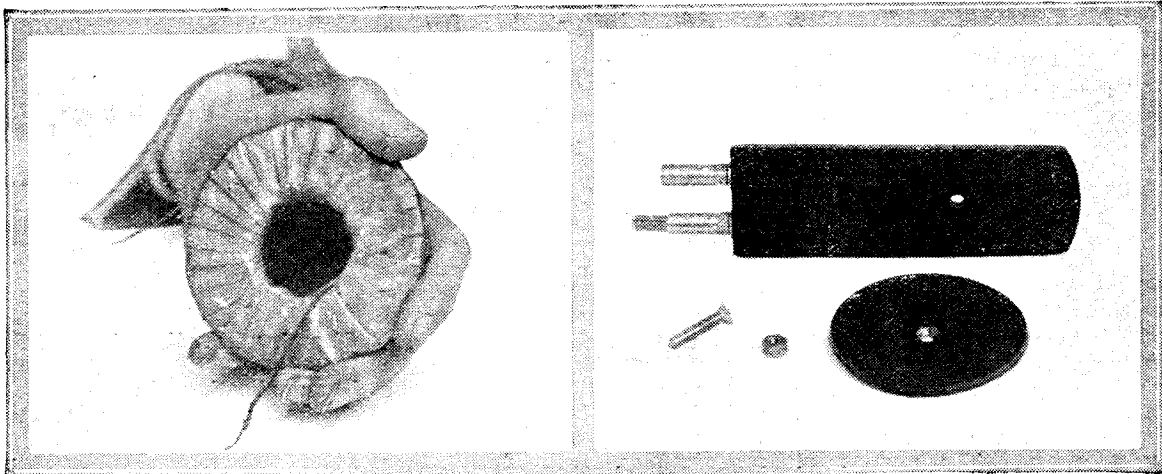

Fig. 7.—Ready for mounting.

THERE is a great fascination in winding your own wireless tuning coils whether they be single layer coils, basket coils, "honeycombs" or "duolaterals." Probably the simplest coil for the beginner to tackle is the double basket, for which you will need some kind of former. Several useful and inexpensive basket coil formers are obtainable commercially and I have illustrated one generally used type in the photographs. This has a brass

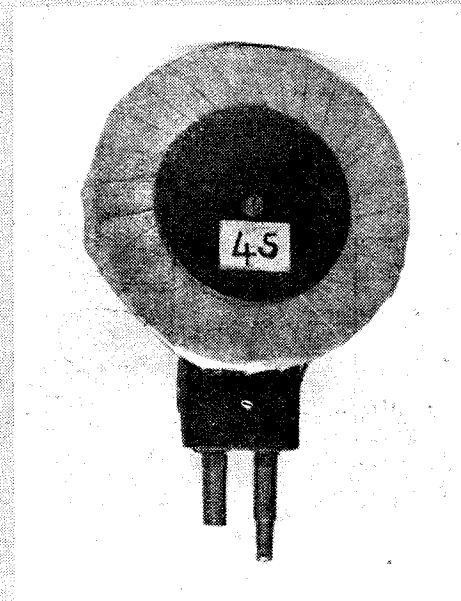

Fig. 8.—A useful mount.

hub about 1¼ in. in diameter with fifteen brass spokes which fit into equally spaced holes around the periphery.

To make a few suitable tuning coils to cover broadcast wavelengths is a very simple matter. You will need to begin with about four ounces of No. 22 double cotton-covered wire and the former shown. Take one end of the wire and secure it temporarily to the former by twisting it round one of the spokes. Now wind the wire in and

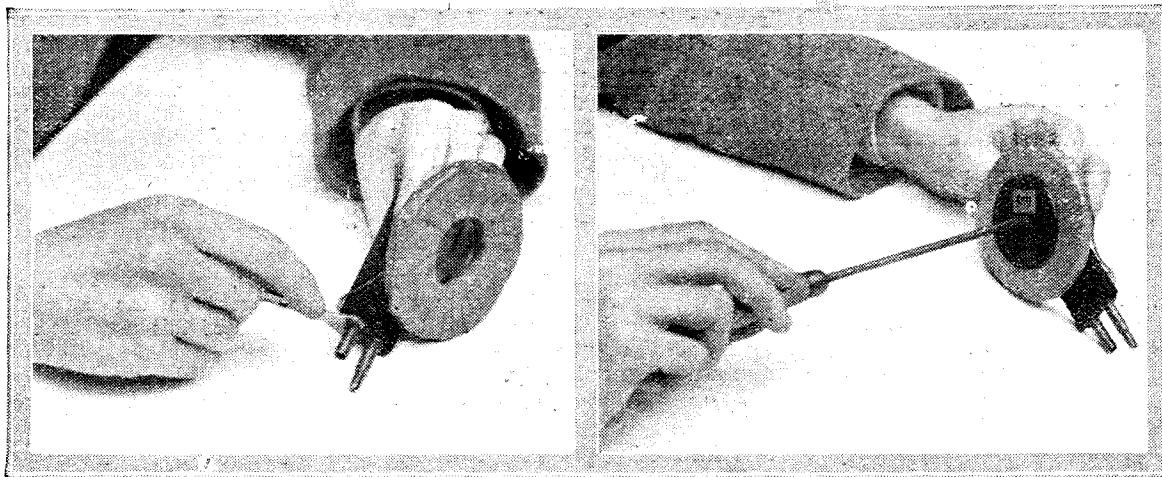

Fig. 10.—Securing wires to pin and socket.

Fig. 11.—Tightening up the locking screw.

Fig. 9.—The finished coil.

out of the spokes as shown, going over and under two at a time. A thirty-turn coil is a useful size to start with, and when the thirtieth turn has been reached tie the last turn to the one below with cotton.

The coil should now be dried out in a warm oven, to remove any possible moisture in the cotton covering, and then varnished with dilute shellac varnish and baked thoroughly. The pins should be pulled out with pliers while the coil is still warm, after which it can be taped with strips of empire cloth and mounted.

The mounting can be bought ready made quite cheaply, and it is then only necessary to secure the two ends as shown and to label the coil with the turn numbers for reference. The number of turns of these coils can be approximately equivalent to the numbers of the commercial coils that would otherwise be used.

A Secure Method of Fixing Heavy Leads.

WHEN it is desired to join long and heavy leads to a terminal, difficulty is sometimes experienced in making the solder support such a large weight. This trouble can be overcome by slipping a small piece of tube over the terminal shank and pushing the wire into it. The tube should first be tinned inside. This can be effected by heating the metal tube and dipping it into a liquid flux, then reheating and dipping into melted solder. A tin lid is ideal for holding the latter. On withdrawing the tube it should be shaken well to remove any excess of metal inside. The terminal shank should

also be well tinned, and the tube then slipped over it. A little flux should next be placed in the tube, and the wire slipped into position.

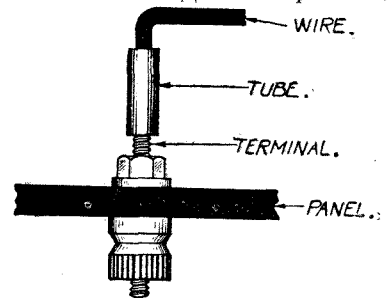

Showing how the piece of tube is used for supporting the joint. The application of a hot soldering iron and a little solder will secure the whole into a solid joint. Tube should be purchased with a bore of $\frac{3}{8}$ in., which comfortably goes over 4 BA threads. The accompanying sketch will clearly explain the method.

HOW TO SAVE SIXPENCE.

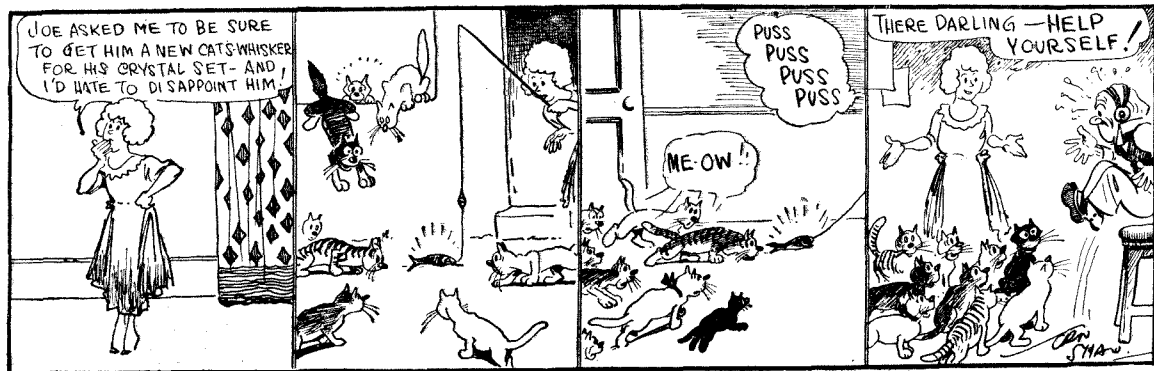

A Chat about Wireless Weekly.

WIRELESS WEEKLY is the most influential of British Wireless Journals. It is the dearest weekly paper but it gives excellent value and has a very large following amongst those who want the best and are prepared to pay for it.

It is read by the best type of experimenter, but it is in no sense a highly technical paper. You are proud to be able to say that you read *Wireless Weekly*. There are splendid constructional articles in every number and a regular feature is made of new circuits and novel methods.

There are five very widely read

regular features which find no parallel in any other paper:—

1. The Editorial leading article epitomises what the world of wireless is thinking to-day. A reasonable but fearless attitude has resulted in this feature being received in all quarters with respect.
2. "Jottings by the Way," is not only the wittiest and brightest feature in wireless journalism, but ranks as a model of humour. These weekly jottings are written by a contributor to *Punch* who is also a wireless authority.
3. "Valve Notes"—a weekly chat on new circuits, new methods and interesting practical hints by John Scott-Taggart, F.Inst.P., A.M.I.E.E. A real fund of absolutely up-to-date practical information on the use of valves.
4. "Apparatus we have Tested." New apparatus is put to stringent

tests by a highly competent physicist, and the results, good or bad, are published with fearless impartiality. Both the wireless trade and the public look to these reports for real information.

5. "Correspondence." Read what other readers are saying and doing and you will realise what a "live" weekly we publish.

6. Special issues commence on Wednesday, October 22nd. See announcement in the advertisement pages of this magazine.

Order the next Issue of "The Wireless Constructor" NOW. READY NOV. 15th.

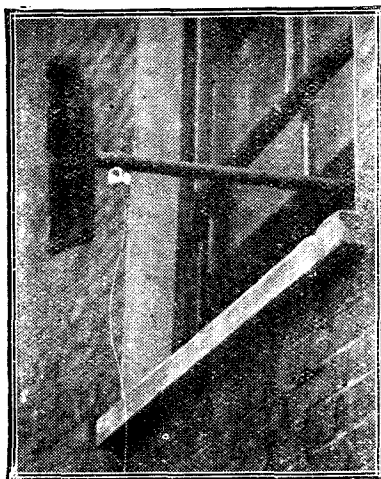

Our mast.

JUST as a nurse, tending fever patients in a mosquito-ridden land, will work for years unharmed, but at last succumbs, so it is with me.

For years I have moved among men who babble of neutrodynes, anodes, and reaction, as ordinary mortals discuss the merits of rival cigarettes or of the days winners (?) Men, some of whom seemed as though they could not possibly have "got" radio by infection, but must have inherited it as people inherit a religion, and had been born with an earth-clip in their mouths, so to speak. Even among the high priests of the cult did my daily duties take me; but familiarity begot awe, rather than its usual offspring. Among such a bewildering mass of experiment and costly apparatus, cryptic signs, and mazes, both of ink and of wire, where dare a timid mortal enter with any hope of finding himself again?

As usual, when man falls, he attributes the blame to a woman.

Cherchez la femme!

Taunted with having for so many years handled radio without having become possessor of a "set," I rushed to the nearest dealer (not far to go!) and spent quite a lot of good cigarette money upon the first things I saw, and took them home.

My wife, having at last roused me to definite action, promptly asked a neighbour round, combining the invitation with a request to bring along certain new gramophone records, to play "while father messes about with his new wireless." (The pitying tone is easier imagined than described.)

The scullery seemed to offer the best "earth," as well as the

The Radio-Bug gets a Bite

This article includes a unique photograph of this troublesome insect in the act of striking.

By D. CHARLES

most secluded retreat, so it was there I hid me with my purchases, a pair of pliers, and some wire left over from installing an electric bell some years ago.

From an upper window a length of this wire was hung in imitation of what I had seen done elsewhere. The height of my mast above the ground was quite 21 feet 7 inches and the wire came down between two buildings, so there was little draught to blow the wireless waves about.

"Heard anything?"

Just as I had got the mast securely guyed to a suitable support and had begun to scrape the paint off a water-pipe in the most approved manner, an upstairs door opens, and a familiar voice enquires, "Heard anything yet?"

The answer was in the negative.

Since too dilatory a procedure might adduce further enquiries of a similarly conciliatory nature no time was wasted in unnecessary elaborations, such as building a cabinet or drilling an expensive ebonite panel. The parts of the set were connected in the minimum of time and with the utmost simplicity as may be gathered from the snapshot of it which I managed to

secure before the daylight faded entirely.

The lead-in

The aerial wire was led in through the open door, and to support it clear of obstruction it was wound once or twice around the neck of a vinegar bottle stationed upon the corner of the table, before being connected to the set. In similar manner a piece of wire was fastened to another terminal, and being also supported by the same bottle, was twisted round the scraped water-pipe.

Carefully putting on the phones I waited for the interval after a record, the dulcet sound of which came through the floor. Steadying the set with the forefinger of one hand the various gadgets were gently adjusted till a faint voice reached my ears. The sound was repeated slightly louder. The repetition was accompanied by strange manifestations. The vinegar bottle crashed to the floor. The set itself began to dance violently upon the table.

More trouble

Scorning psychic influences, I extricated the kitten from the now tangled aerial with the utmost

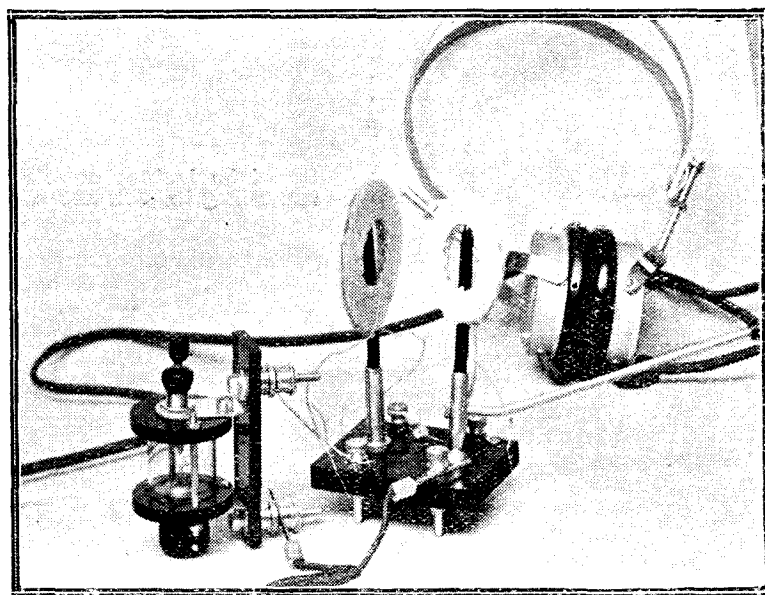

My first wireless set: how it attained success after overcoming many heartrending episodes is herein recounted.

composure and with the loftiest considerations for humanity.

Having once more assembled my wireless set a violent ring at the front-door bell announced the arrival of the neighbour to fetch his wife (with records). Informing me of this fact the intervening doors were necessarily opened also, and the neighbour's dog appeared on the scene in a desperate hurry to interview the aforementioned cat. He too became involved in the wiring system.

As soon as I had managed to combine my desperate efforts at saving my set from destruction, with equally desperate apologies for a surely excusable aberration of speech, the dog began again to manifest interest in the whereabouts of the cat. The neighbour's little boy, endeavouring to recover possession of the dog, also came into collision with the wires.

At last

Murmuring further apologies, a third (or was it a fifth) attempt was made, this time amid a thoroughly interested concourse, to get into communication with 2LO. It was not, however, till some time after the company had decided to depart, that sounds, undoubtedly of singing, were actually heard in the phones. A little adjustment, and the singing became a duet, faint, but clear. Later on instrumental music was also heard.

I felt a swelling in my throat. The radio-bug had bitten me at last!

A cloudy dawn

Next morning breakfast time was marred by a cloud. I was told of several families into which the introduction of wireless had brought dissension. At least one divorce had lately been directly caused by the infection. The symptoms were described in detail.—The sudden aversion from speech.—The intent look.—The terrible fascination of the little black knobs.

Nevertheless, in the evening, the bite being still in the inflammatory stage the set was again, though in some trepidation, placed upon the table, and connected to earth and aerial as before. The small daughter displayed much interest in the novel arrangements. Since she is of the age when "How?" and "Why?" are prominent in the vocabulary, the concert was not entirely free from atmospheric of various kinds.

The proceedings were extraordinarily amusing to her mother. After a while, curiosity naturally began to assert itself. Disdainfully fixing on the phones (such "horribly

uncomfortable things") silence was demanded.

That intent look —

"Be quiet, can't you, child, when I'm listening to *Bedtime Stories!*"

The radio-bug had got another victim!

Next morning the breakfast passed quite pleasantly. As I reached for my hat, "How much would a loud speaker cost?"

Truly, the radio-bug has bitten well, and bids well to bite deeply into my purse as well.

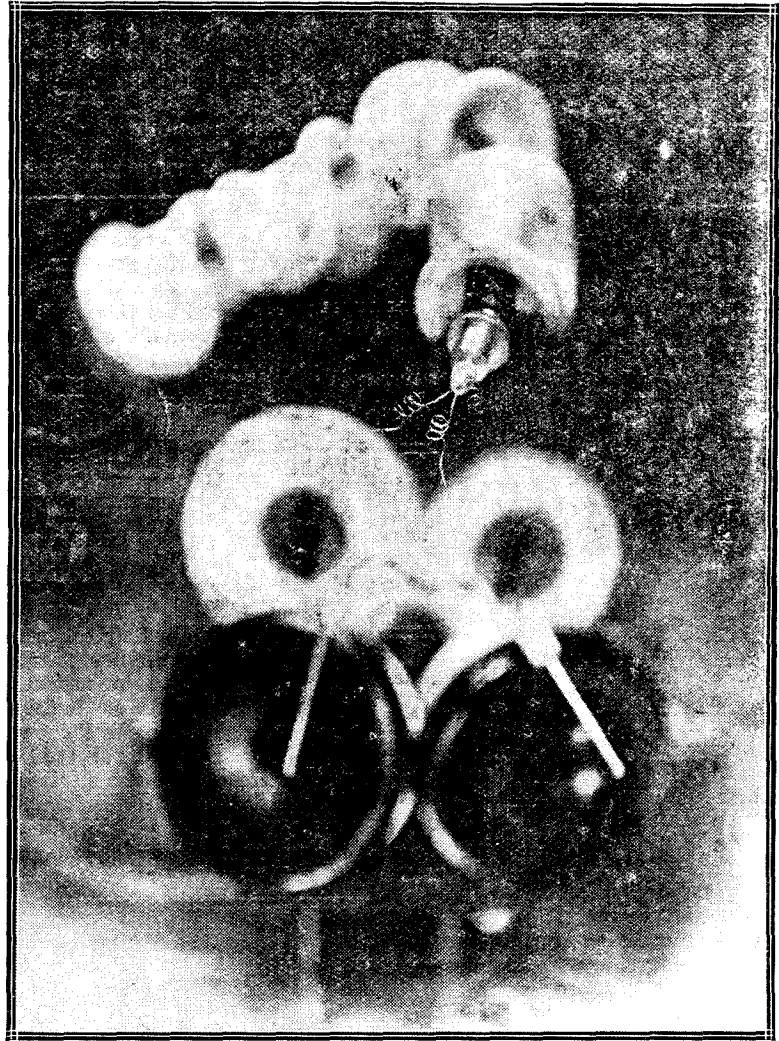

Special wireless construction high-power photograph of a radio-bug in the act of striking. Very strictly copyright.

Radio Books to Read.

IF you are new to wireless, you may not be aware that Radio Press, Ltd., the proprietors of THE WIRELESS CONSTRUCTOR, do an enormous business in books on radio which are distinguished by their accuracy and general usefulness. A complete list appears in the advertisement pages, but some guidance here may be helpful.

Each book of the Radio Press Series is numbered, and although they are not intended to be read in the order of numbers, the beginner starts with No. 1, "Wireless for All" (6d. net), and then reads No. 2, "Simplified Wireless" (1s. net), which follows on from No. 1, although each book is complete in itself. Both are by an expert in lucid explanation.

You can then buy "How to Erect Your Wireless Aerial" (1s. net), and "How to Make Your Own Broadcast Receiver" (1s. 6d. net). If you want to learn something about valves, "Radio Valve and How to Use Them" is so clear that any beginner can follow it.

If you want to build a set, the Envelopes are ideal, or you can buy that extremely popular book, "Twelve Tested Wireless Sets," by Percy W. Harris. If you want to make your own coils, read "Tuning Coils," by G. P. Kendall, B.Sc.

Examine carefully the list given in the advertisement pages and buy one or more of the books. A Radio Press book has never yet let anyone down.

How to Fit a Valve into a Holder

IT is quite probable that more valves are ruined by incautious insertion into the sockets, and the consequent burn-out by the high-tension battery

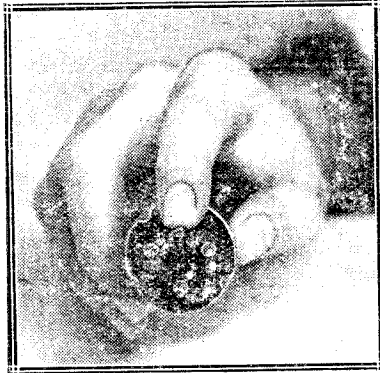

Fig. 1.—The forefinger is placed against the grid leg of the valve.

than by disintegration of the filament after long service.

Luckily, owing to the fact that the pins of standard English valves are "staggered," these accidents are

not common, and can be avoided if a little care is taken when fitting valves into their sockets.

British manufacturers have noted this possible source of damage to valves, and are producing valve-holders in which all metal parts are recessed, thus preventing the valve from making contact until it is properly inserted.

A Safety Device.

A safety device, similar to the foregoing in principle, may be easily made by affixing to the top of the holder a small disc of ebonite having holes drilled in it to allow for the insertion of the valve legs.

All "live" metal parts are thus countersunk, and wrong insertion of the valve is rendered impossible.

An Easy Method of Ensuring Safety.

It should be remembered, too, that valves need most careful handling when being inserted into their holders, for the greatest strain is then placed on the connecting pins. Should these work loose or become detached from their short

interior connection, the trouble will be most difficult to rectify.

An easy method of ensuring safety is to look at the pins of the valve before inserting into the holder, and to place the forefinger against the grid leg. On looking at the socket, the forefinger is kept close to that part of the socket where the grid leg is to be inserted, and the valve gently pushed home.

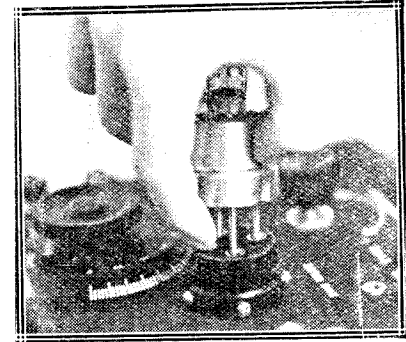
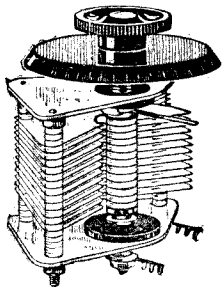

Fig 2.—The valve is inserted by keeping the finger near the correct socket.

Fig. 1 shows how the valve is held in the hand, before insertion into the holder, and Fig. 2 shows how the finger is placed near the correct socket.

BUILD EFFICIENT TUNING INTO YOUR SETS—a timely warning



SUPER	
.001	9 3
.00075	9
.0005	8
.0003	6 9
.00025	6 9
.0002	5 6
.0001	5 3
Vernier	4 6

While for ordinary practical purposes the straight capacity curve condenser proves satisfactory, occasions arise for really accurate tuning when those instruments prove ineffectual. Accuracy—that is definite wave-lengths actually separable and equidistant on the scale—demands the Square Law Type.

The universal popularity of condensers emanating from us makes the J.B. Square Law an already familiar product in the sets of all experimenters who pride themselves on the efficiency of their tuning arrangements. Skilled craftsmanship, careful choice of raw material and good design all combine to persuade you to fit the J.B. Square Law Condenser; incomparably efficient—employing

the straight wave-length curve.

As an engineering job "J.B." Condensers set a standard among popularly priced instruments. An ingenious compressing spring supplants the very inefficient split washer; plain metal-to-metal bearings supersede the threaded centre spindle and specially designed spacers keep resistance losses down to the irreducible minimum.

SQUARE LAW	
.001	9/6
.00075	9/-
.0005	8/-
.0003	6/9
.00025	6/9
.0002	5/6
.0001	5/3
Vernier	4/6

It is of paramount importance to be assured that once condensers are fixed they remain permanently operative. Lesser precise products frequently become useless after short usage. The consequent dismantling and replacement is saved by fitting a J.B., which is well worth the few extra pence which buy them

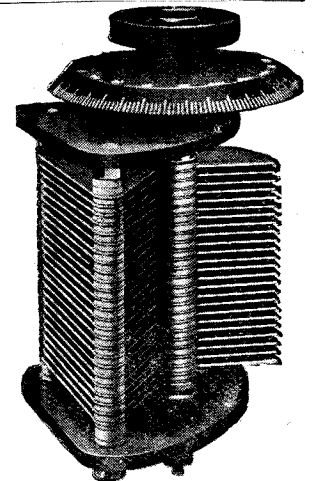

STANDARD	
.001	8 6
.00075	8
.0005	7
.0003	5 9
.00025	5 9
.0001	4 9
Vernier	4

JACKSON BROS.
B. POLAND ST- OXFORD ST.
LONDON - W.1 Telephone-
GERRARD 7414

Do not be misled into believing that any condenser is equal in efficiency to the "J.B." Set builders employing variable condensers cannot be certain of building tuning efficiency into their sets unless they use condensers bearing our Regd. Trade Mark. It is indicative of precision and skilled manufacture.



Some Interesting Questions Answered

AERIAL DIMENSIONS—INDOOR AERIALS—ELIMINATING INTERFERENCE.

What are the present regulations regarding the dimensions of an amateur receiving aerial?

THE regulations permit the use of an aerial the combined length and height of which must not exceed 100 ft., irrespective of the number of wires employed. It is further understood that the height really refers to the length of the down-lead. An aerial 80 ft. in length with a down-lead of 20 ft., or one having a length of 50 ft. and a 50 ft. down-lead, would comply with the regulations, and either aerial could consist of a single wire, two or three wires and spreaders, say, 6 ft. in length, or even four or six wires arranged upon circular hoops.

What is the best arrangement for an indoor aerial?

To obtain the best results, an indoor aerial should be as high as possible. The highest indoor posi-

tion in any house is immediately beneath the roof tiling. In general, owing to lack of space, it will be necessary to compensate by the use of a number of wires in parallel joined together at one end, and a carefully insulated down-lead taken to the receiving apparatus. An aerial consisting of 6 or 8 parallel wires, attached to insulators screwed to the underside of the roof framing, is the best possible arrangement. In actual practice such an aerial gives excellent results, especially if used in conjunction with a fairly sensitive valve receiving set.

In the absence of a convenient main water pipe, what alternative earth connection can be used?

1. An old galvanised iron bath or bucket, perforated with holes, should be buried a foot or two beneath the surface of the soil, under-

neath the aerial and as close to the "leading-in" point as possible. A stout copper wire should be soldered to the upper edge of the bath or bucket, which should be almost filled with cinders or preferably broken coke. Three or four bucketfuls of water should then be poured in and the earth shovelled back. 2. A corrugated galvanised-iron sheet (as large as is available) should have a stout copper wire soldered to one corner, the plate being buried on its edge until the upper edge is 6 or 8 in. below the surface of the ground. The hole in which it is placed should be about half filled with cinders or broken coke, water should be poured in and the earth replaced and stamped down. 3. If sufficient space is available, two (or more) long lengths of bare copper wire, not necessarily new, may be buried some 6 or 8 in.



SPECIALITIES

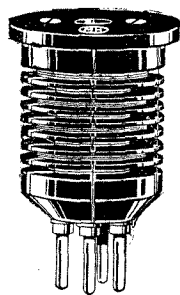
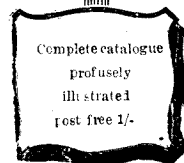

H.F. PLUG-IN TRANSFORMERS

No. 00.	80 to 150 metres	8/-
No. 0.	150 to 300 metres	7/-
No. 1.	300 to 600 metres	7/-
No. 2.	550 to 1,200 metres	7/-
No. 3.	1,100 to 3,000 metres	7/-
No. 4.	2,500 to 7,000 metres	7/-
The Complete Set		£2.
Can be supplied in matched pairs at NO extra charge.		

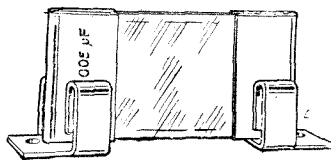

CONDENSERS

Each supplied with two Clips.
Prices:
0.001 μ F to 0.0001 μ F 1/4 each.
0.01 μ F to 0.02 μ F 2/- each.



L.F. Transformers 21

VISIT RADIO CORNER

AND SELECT YOUR
SETS and COMPONENTS

L.M^cMICHAEL LTD
IN CONJUNCTION WITH B. HESKETH LTD

WIRELESS ENGINEERS,
Radio Corner, 179, Strand, London, W.C.2.

Easily made Plug-in Coils for 5XX

ON the longer waves, where the frequencies are lower, consideration of coil self-capacity is not so vital as on the broadcast wavelengths and below,

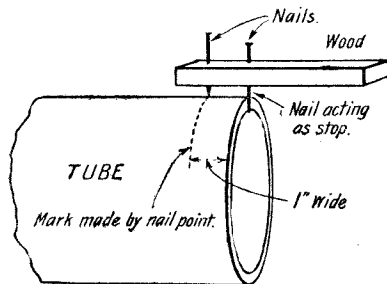

Fig. 1.—Showing how to mark off evenly a piece of cardboard tube.

so that coils for 5XX may be pile, or even slab wound. No wax or shellac should be used if maximum signal strength is required.

Space consideration precludes the use of heavy gauge wire, but this will not be found a very serious disadvantage. No. 28 D.C.C. will be found suitable for the purpose.

The materials required for two coils, one for the aerial coil and one for the anode or reaction, are as follows:

Two coil blocks suitable for coil mounting with side screws.

One ft. by 1 in. fibre strip

Three yards Empire tape $\frac{1}{2}$ in. wide.

Half lb. No. 28 double cotton covered copper wire.

A short length of impregnated cardboard tube, 2 in. diameter.

Two pieces of wood 4 in. by 4 in. by $\frac{3}{8}$ in. thick will also be required, and a large wood screw.

Procedure

Cut off a piece of the cardboard tube 1 in. in width with a sharp pen-

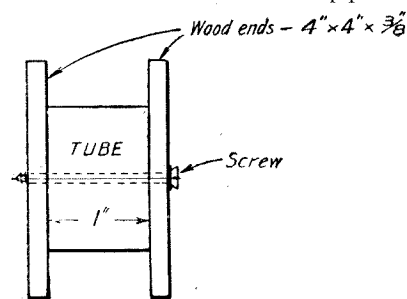

Fig. 2.—The wooden ends are secured to the cardboard tube by a screw.

knife. An easily made gauge for marking off the correct width can be made by knocking two nails through a handy piece of wood, so that the first nail makes a mark on the cardboard tube when drawn round it, and the other acts as a stop. Fig. 1 shows this in use.

Making the coil former

The two pieces of wood are then taken and a $\frac{1}{4}$ in. hole drilled through the centre of one and a gimlet hole made in the centre of the other. The large wood screw is passed through the big hole in the first piece of wood, placing the cardboard former in a central position, and the screw driven into the gimlet hole, the whole being then tightened up, as in Fig. 2.

One hundred and fifty turns of wire are then wound in the wide slot thus formed, in the case of the aerial coil, or two hundred turns

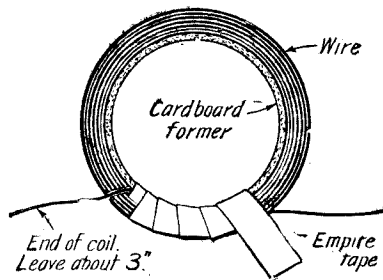

Fig. 3.—The coil, removed from the former, has a few turns of tape wound round as shown.

for the anode coil. The wood screw is then removed, the blocks of wood taken away carefully and four or five turns of "Empire" tape wound round the coil, including the cardboard former as in Fig. 3.

A $\frac{3}{8}$ in. hole is made in the fibre strip about $\frac{3}{16}$ in. from the end, and in the middle of the strip. This is fixed into position by the screw found in the side of the coil plug.

Securing the coil to the coil block

The coil is then placed in position on the coil plug, and the fibre strip passed round it so that the correct distance and length of fibre may be found. At $\frac{1}{8}$ in. shorter than the actual length of fibre required is made another $\frac{3}{8}$ in. hole. The fibre is cut off and fixed to the block by means of the screw pro-

vided. The coil should then appear as in Fig. 4. The coil is next bound up tightly to the fibre strip by means of "Empire" tape all the way round and finished off as shown in Fig. 5. The free end is passed under the last turn of tape and cut off neatly with a knife.

The ends of the wire are then bared and placed under the con-

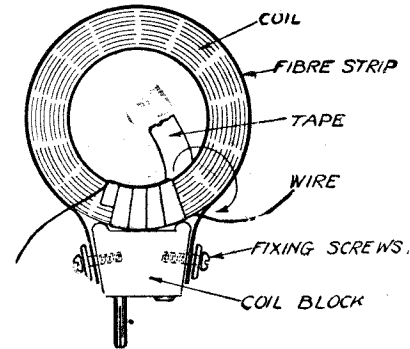

Fig. 4.—The coil mounted upon the block, and secured by the fibre strip.

necting screws, and the coil is ready for use.

The coil can be taped up before it is held by the fibre band, but if this is done it will be found that the coil is not securely held to the block, and may after a time easily slip out of place.

The writer has made several complete sets of this type of coil from twenty-five turns upwards which have given excellent results. A list of sizes and quantity of wire required is appended.

25	20 S.W.G., D.C.C.	200	} 28 S.W.G. approx.
35	$\frac{1}{4}$ lb.	250	
50	22 S.W.G., D.C.C.	300	} 1 lb.
75	$\frac{1}{4}$ lb.	350	
100	24 S.W.G.,	400	} D.C.C. 6 oz.
150	D.C.C.	6 oz.	

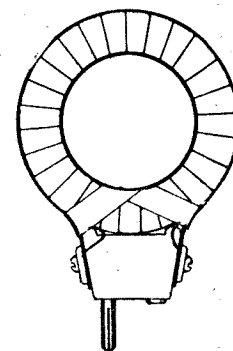

Fig. 5.—The completed coil is covered with Empire tape and presents a very neat appearance.



Switches in Wireless Circuits

Simple Arrangements Pictorially Explained

Series and parallel aerial condenser—Tune and stand-by—Crystal or valve—Adding a valve with a jack switch—Cutting out the H.F. valve.

The Tune and Stand-by Switch

An arrangement by means of which either the aerial coil or secondary coil in a loose-coupled circuit may be connected to the

detector or H.F. amplifier which follows is shown in Fig. 2. The aerial and earth leads remain connected to the aerial coil in each case. As will be seen, a double pole, double-throw knife switch is employed for effecting the change, the two centre contacts being taken to the detector or amplifier as indicated by the arrows.

The difficulty in tuning which is generally associated with loose coupling is considerably reduced when the switch is included. Under the conditions illustrated the aerial coil only is employed, and consequently tuning is carried out merely by adjustment of the aerial tuning condenser. Now, by placing the switch in the other position, the secondary coil is switched into circuit, and tuning on the secondary circuit condenser, with slight adjustment of aerial condenser, should bring in the previously tuned signals provided the secondary coil is of the correct size.

Valve or Crystal Rectification

A simple change-over device permitting the use of either crystal or

THE first illustration shows three arrangements permitting the aerial tuning con-

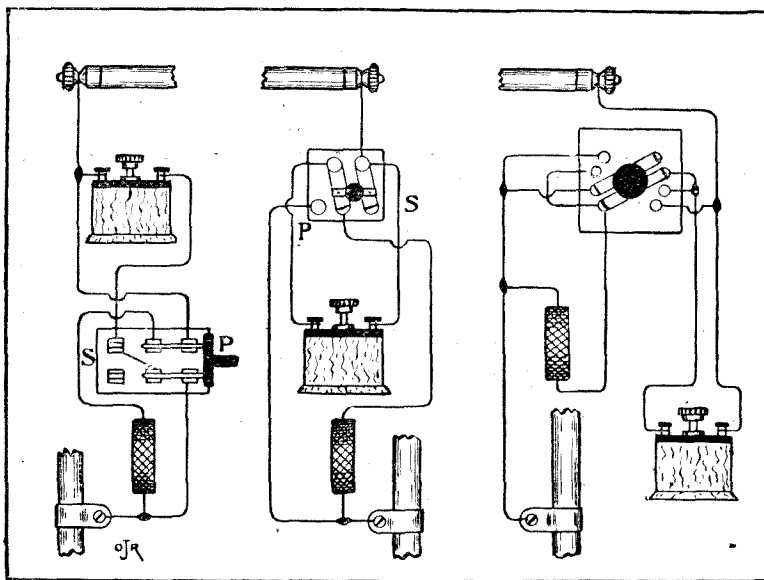

Fig. 1.—Three different methods of series-parallel switching.

denser to be placed either in series or parallel with the aerial tuning coil. One great advantage in having so handy a means of effecting this change is the ease with which the two methods of tuning may be compared on any wavelength.

Fig. 1 (left) shows how series-parallel switching is accomplished with a knife-switch of the double-pole, double-throw type. Fig. 1 (middle) illustrates a simpler method of achieving the same purpose, and in this case two switch-arms and three contact studs are utilised. Another method may be seen in Fig. 1 (right), which is particularly suitable for panel mounting.

As regards the comparative efficiency of each method, it is probable that for general purposes none of the three types of switch will exhibit marked superiority.

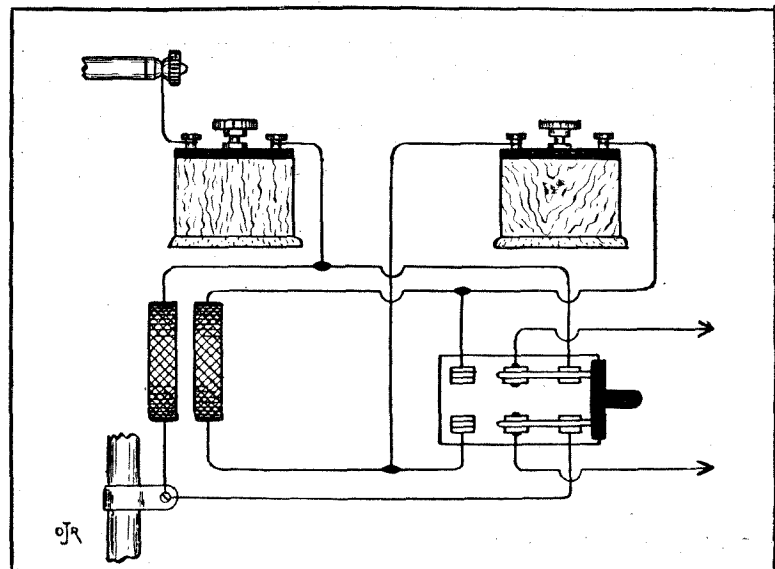

Fig. 2.—A useful tune and stand-by arrangement.

mitting the use of either crystal or valve rectification is depicted in Fig. 3. This proves very useful when it is desired to test the merits of the two detectors on long range reception, as it is much easier to make comparisons when a quick change-over is possible. Other uses will, of course, occur to the reader. Two well insulated knife switches, B and C, are used. When these are set as shown, the crystal detector is in use, and when each switch is reversed the valve detector comes into operation. In the former case the top portion of B connects the aerial to the crystal detector and the lower portion connects one side of the telephones to earth. These latter are included in the crystal detector circuit by means of C. The reversal of the switches results in the aerial being connected to the grid of the valve through the grid-leak and condenser through B, while C places the telephones in the anode circuit.

Switching in a Note-Magnifier by Means of Spring Jacks

The inclusion of the jacks J₁ and J₂ in the crystal and note-magnifier circuit illustrated in Fig. 4 makes it possible to use either the crystal receiver alone or the crystal detector with a stage of low-frequency amplification by merely plugging the phones into J₁ or J₂. J₁ is a 4-point, and J₂ a 2-point jack. The plug is illustrated separately and is marked P, while the telephone leads which are connected to this plug are indicated by T. By plugging into J₁ the telephones are connected between one side of the

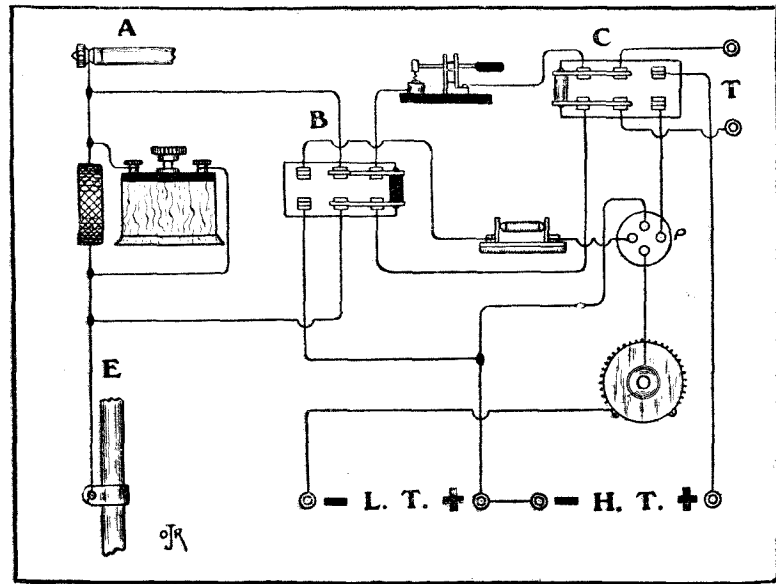

Fig. 3.—Switching-in crystal or valve detector.

crystal detector and the earth, the primary winding P of the interval transformer being cut out of circuit. This, of course, brings the crystal receiver into use. By taking out the plug and inserting in J₂ the phones are placed in the anode circuit of the valve, where much louder signals may be obtained. Where panel space is limited this system of switching has much to commend it.

If it is desired to add a second stage of note-magnification to this circuit, J₂ may be connected between the high tension plus terminal and the plate of the primary of

the following transformer being also made to those points. H.T. — and L.T. +, the points between which the jack was originally connected, should be joined directly together.

A better way is to use a second jack of the same pattern as J₁, using J₂ between the plate of the last valve and the H.T. +.

Switching of Tuned Anode H.F. Valve Preceding Valve Detector

Figure 5 shows the wiring of a circuit in which a D.P.D.T. switch is employed to cut out the stage of tuned anode high-frequency amplification preceding a valve detector. The upper arm of the switch S cuts off the filament current of the first valve when required, and the lower arm joins the aerial, or the plate of the first valve, to the grid of the second valve through the grid condenser. The upper and lower arms are of course moved simultaneously in the usual manner. With the switch in the right hand position as shown, the anode of the H.F. valve is connected to the grid condenser of the rectifier, and the filament current of the first valve switched on. Thus both the H.F. and detector valves are in use. With S in the left hand position the negative filament lead of the H.F. valve is broken, and the currents from the aerial pass through the lower arm to the grid condenser of the rectifier.

Tuning is carried out by adjustment of the aerial tuning condenser in each case, but when the two valves are used variation of the anode tuning condenser is also necessary. It should be noted that

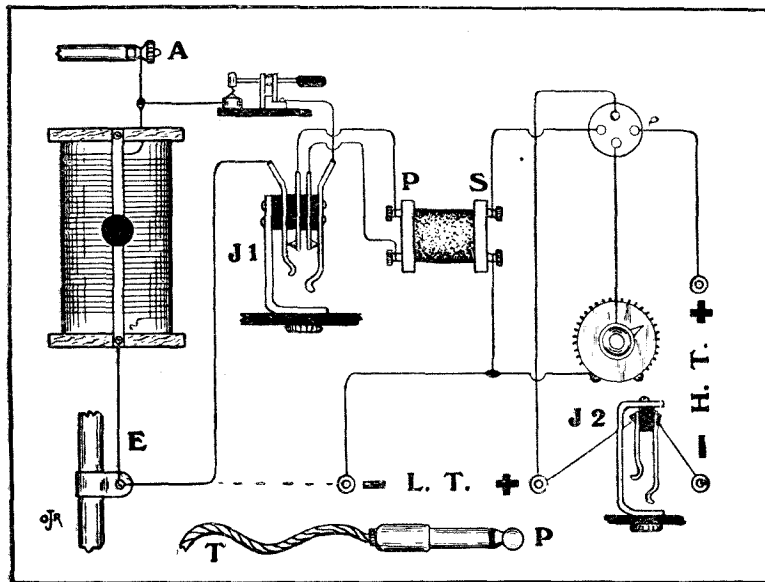
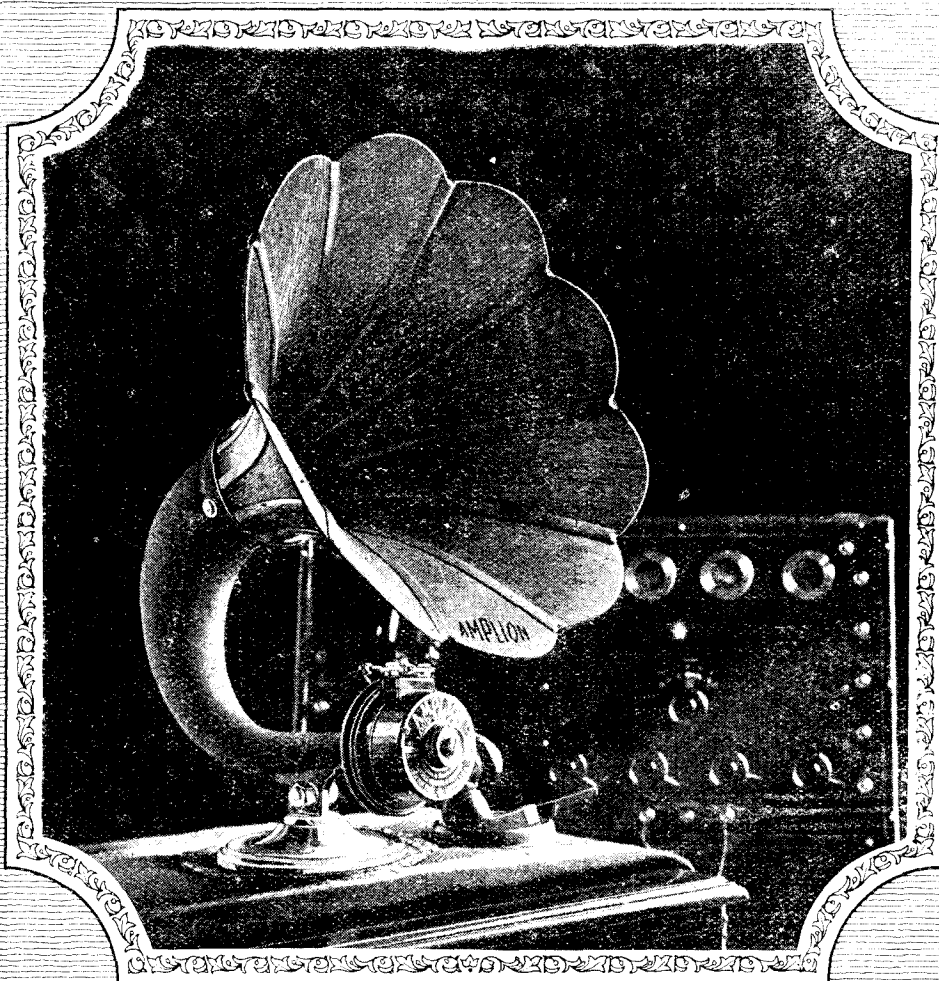

Fig. 4.—Adding a note-magnifier by plug and jack. Generally you should connect OS to grid, IS to the filament resistance, IP to left middle contact and OP to right middle contact of jack switch.

AMPLION



The World's Standard Wireless Loud Speaker

A MPLION LOUD SPEAKERS are world-famous for sensitivity, full volume, clarity and wonderfully natural tone—qualities due to the incorporation of many exclusive features, including a non-resonating sound conduit with wood horn and an improved unit embodying the "floating" diaphragm.

ALFRED GRAHAM & COMPANY (E A GRAHAM)
 St. Andrews Works, Crofton Park, LONDON, S.E.4

Pilot Panel Service

WHEN a man decides to build a good Receiving Set he immediately comes up against the difficulty of a suitable cabinet and the drilling and engraving of the Panel. Cabinet making is a skilled man's job and many a perfectly good piece of ebonite has been spoilt by a hole in the wrong position or because it has been incorrectly cut to size. To eliminate most of the difficulties in Set-building we have instituted the "Pilot" Panel Service. In future all Sets described in *Modern Wireless* or *Wireless Weekly* will be available in sets of parts for the Home Constructor with panels ready drilled, tapped and engraved. Two types will be placed on the market—Type A following the author's literal specification and using his actual components and Type B, an adaptation using Peto-Scott guaranteed components. Naturally, through standardisation of components and our lower manufacturing costs due to large output, Type B will show a large saving over Type A.

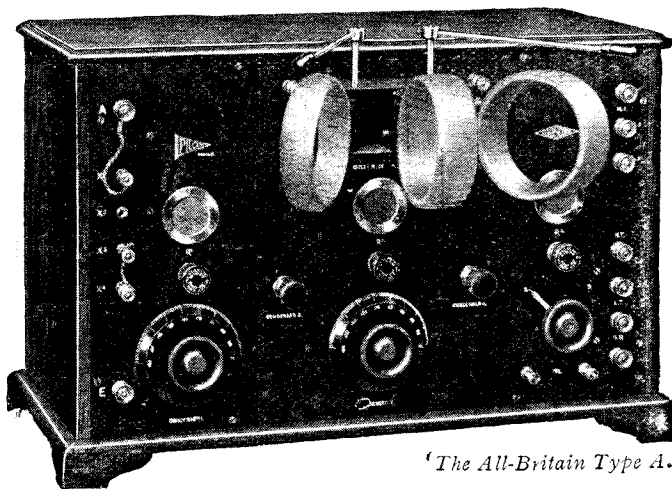

'The All-Britain Type A.'

The All-Britain Receiver

(*"Modern Wireless," Sept. Issue.*)

The new All-Britain Receiver in the September issue of *Modern Wireless* is proving one of the most popular Sets of the season. A 3-valve Set, it has much to recommend it on account of its simplicity and ease of operation. By including it in our "PILOT" Panel Service experimenters are able to build it up at a big reduction in cost. It should be noted that the author's design of the All-Britain Receiver is so similar to our own standard Type B Receivers that the Cabinets for both types are identical. The fundamental difference is that in Type A the Valves project outside the panel in a horizontal position while in Type B they are totally enclosed at rear of panel entirely out of harm's way. Therefore, in the list of prices it will be seen that Pilot Cabinet B is fitted with an additional baseboard to screw on to the ebonite panel to carry all the components.

PRICES :

- Type A.**—Ebonite Panel, guaranteed Post Office quality, of highest grade, 10 in. by 16½ in., drilled, tapped and fully engraved 16/-
 Polished Oak Cabinet, with sliding back, to take above panel 15/6
 Complete kit of components, exactly as author's specification, but with Max-Amp Transformer and Peto-Scott all-ebonite improved Coil Holder £4 12 0
- Type B.**—Ebonite Panel, guaranteed Post Office Ebonite of highest grade, drilled and tapped to take Peto-Scott guaranteed components, size 10 in. by 16½ in., matt finished by hand 10/-
 Engraving extra 3/-
 Polished Oak Cabinet, with sliding back, but fitted in addition with panel baseboard 17/-
 Complete kit of guaranteed Peto-Scott Components. In this kit we include Polar Condensers and Lissenstats, but otherwise everything else is of our own manufacture and fully guaranteed in every respect £4 2 6

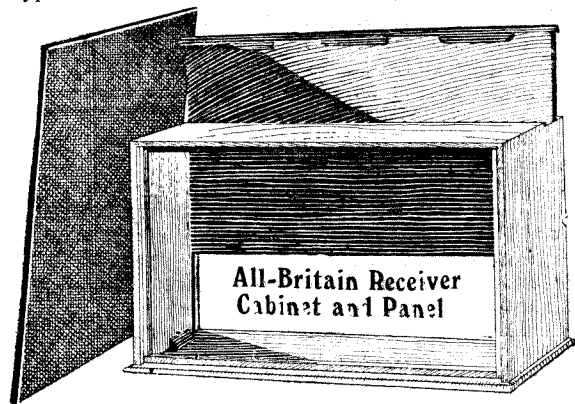

Other Receivers available under the "Pilot" Panel Service

In addition to the Receiving Sets described in this issue of *The Wireless Constructor*, we also supply the following Modern Wireless Receivers in Type A and Type B for home construction. Finished instruments in either type are also available.

- The Puriflex Receiver.
- The All Concert-de-Luxe Receiver.
- The 3-Valve Dual Receiver
- The Transatlantic V (and others).

Our Guarantee

Remember that if our instructions are followed we positively guarantee that all Type B Receivers are the equal in every respect to the more expensive Type A sets. Our Service Dept. is available for all our customers and will test and rectify errors of construction at a nominal charge. We want all our customers to have the utmost confidence in every Set produced under the "Pilot" Panel Service.

PETO-SCOTT Co., Ltd.

Registered Office & Mail Orders : 77, CITY ROAD, E.C.

Branche: LONDON—62, High Holborn, W.C.1. PLYMOUTH—4, Bank of England Place. LIVERPOOL—4, Manchester Street. CARDIFF—94, Queen Street. WALTHAMSTOW—230, Wood Street.

The Family 4-Valve Set

(*Radio Press Envelope No. 2.*)

Exactly as Author's specification, except that an ebonite panel is used instead of one made of wood. This permits components being mounted flush on the panel and greatly improves the appearance of the whole Set. Valve-Holders are of the same anti-capacity type, but of our own manufacture. Two Max-Amp Transformers are supplied instead of one Max-Amp and one Igranic, and an Igranic Potentiometer is substituted for the T.C.B.

- Complete kit of Components, only as above amended specification, £6 1 0
 Ebonite Panel, 24 in. by 8 in. by ½ in., drilled, matt finished, and fully engraved £1 2 6
 Panel only (undrilled and not engraved) 12 6
 Polished Oak Cabinet, 24 in. by 8 in. by 4 in. £1 5 0
Gilbert Ad. 1414.

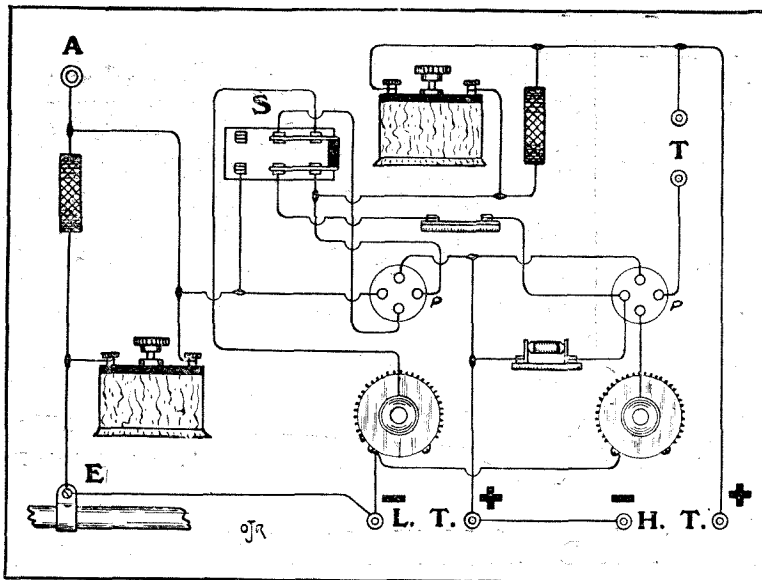

Fig. 5.—How to cut out a high frequency valve.

when the detector valve is used alone the circuit is not highly efficient owing to the absence of a reaction coil. When the two valves are used accurate tuning on the two variable condensers should produce good results, there being a measure of reaction introduced by the valve capacity.

Switching of Single-valve Note-Magnifier

The last figure shows a means whereby a stage of low-frequency amplification may be used or cut out at will with the aid of a D.P.D.T. knife switch. It will be seen that a loose-coupled circuit is employed, though this of course is not essential for the proper working of the switch. With the switch in the position indicated the rectified currents in the anode circuit of the detector valve pass through the lower arm of the switch, and through the primary P of the intervalve transformer to H.T.+. Fluctuating voltages are thus transferred to the grid of the second valve, and amplified currents result in the plate circuit of this valve. A reversal of the switch connects the anode of the detector via the lower arm to the telephones, the filament current of the L.F. valve being cut off by the upper arm in a manner similar to the filament switching used in the previous figure.

A switch connected in this way proves very useful for judging the quality of a L.F. amplifier, and is far less likely to cause inefficiency in the circuit than is a switch employed for cutting out an H.F. valve.

A CONDENSER HINT.

IN conventional circuit diagrams a variable condenser is represented as having two exactly similar plates.

There is no indication as to which are the moving vanes and which are the fixed, and the constructor is often at a loss to know which way round to connect his condenser.

It may be taken as a safe rule that between any two points in a circuit where a difference in high-

frequency potential exists the condenser should be inserted so that the moving vanes are connected on the lower potential side. Thus in a tuned anode circuit the condenser should be wired so that the fixed vanes are connected to the valve plate, and the moving vanes to high tension positive.

Similarly, an aerial tuning condenser should have its fixed plates connected to the aerial and its moving vanes to the lower potential side in order to reduce stray capacity effects.

By observing this simple rule of connections hand capacity effects will be neutralised to a large extent and many sources of trouble will be avoided.

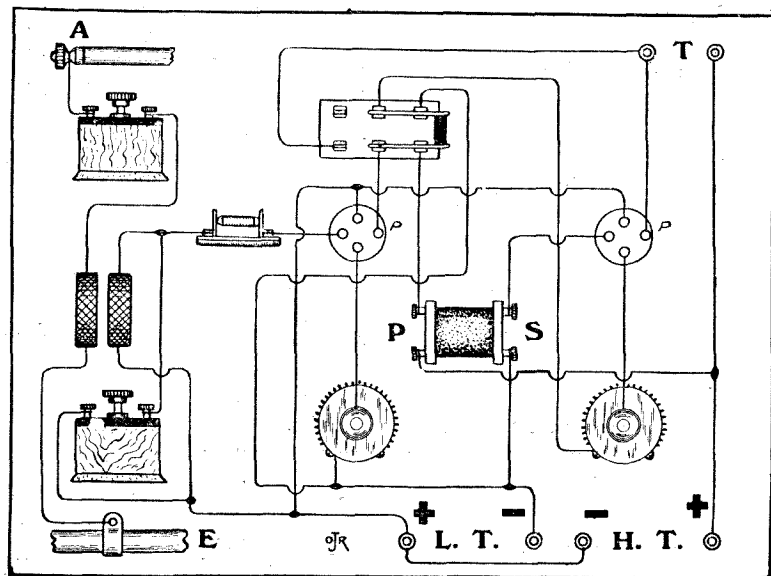

Fig. 6.—Cutting out a note-magnifier following a detector valve.

THE AUTHOR
of this article has written a very popular book, entitled—

*Pictorial
Wireless
Circuits.*

Price 1/6.

By OSWALD J. RANKIN.

Dozens of circuits drawn pictorially as on this page appear with suitable explanations.

The book is No. 8 of the Radio Press Series, and is obtainable from all booksellers.

For the Absolute Beginner

A helpful article to all who have just succumbed to the most fascinating of all applied sciences.

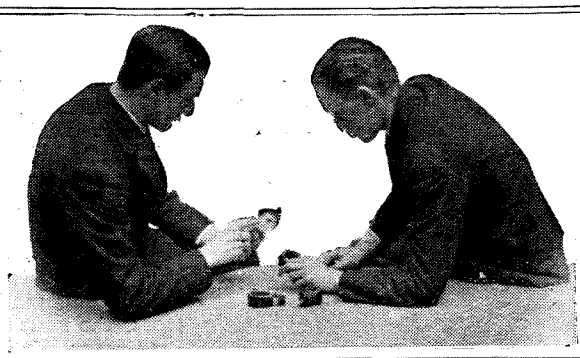

HOME wireless is divided into two classes. There are those who are only interested in broadcasting and the reception of music, lectures, concerts, news items and so on, given out from the several broadcasting stations dotted about the country. There is another class which is primarily interested, although only in a non-professional manner, in the technicalities of the subject of wireless. This latter class is interested not only in broadcasting but in the thousands of the other kinds of signals and messages which are being sent by wireless, such as messages from transatlantic stations, from ships, from aeroplanes, etc.

Where do You Belong ?

Whichever class you intend to belong to you must know something about the subject. The best way of acquiring this is to buy, in the first place, the two very simple little books "Wireless for All," and "Simplified Wireless." You should try to get in touch with someone who has already installed a wireless receiver in your district. If possible, get in touch with a member of the local wireless society, and, preferably, join this society yourself. The fees are small and no technical qualifications are necessary.

Having got some general ideas on the subject you may then ask your friend's advice as to purchas-

ing a wireless receiver. If you are only interested in broadcasting you might, if you preferred, go straight to a wireless dealer of standing and ask his advice, telling him your needs and the amount you desire to pay for your set. If you desire to take up wireless experimenting, or to make your own wireless receiver, you should most certainly get in touch with another wireless experimenter. Your first real step will be to buy a licence from any Post Office. This licence will cost you 10s.

Join a Society

The golden rule for experimenters is to join a wireless society. Another rule for the would-be

THE DEXTRAUDION DULL EMITTER

The "DEXTRAUDION" is the lowest consumption valve in the world—1 volt at .1 amp—The plate potential is from 30-60 volts, and the amplification factor 10.

Absolutely non-microphonic and distortionless!

21/-

ONE TENTH OF ONE WATT

IS THE BRIGHT EMITTER DOOMED ?

Messrs. ECONOMIC ELECTRIC, Ltd.,
10, Fitzroy Square, W.1.

Leigh-on-Sea.
August 2nd, 1924.

Dear Sirs,

I am writing to express my appreciation of your "DEXTRAUDION" VALVE. Words, however, are hard to find adequately to describe your marvellous production. Without any doubt it is the most wonderful valve in the world. Properly handled and advertised it should, and will, supersede all other dull emitters, while the man who still persists in using a bright emitter should LIGHT HIS HOUSE WITH CANDLES to be consistent.

As I write I am listening to 5 xx almost too loud for comfort, and the most strenuous efforts in almost total darkness have failed to detect a glimmer of light proceeding from the filament. In the absence of measuring instruments I can only guess the voltage to be about 0.1. The quality of the music must be heard to be appreciated, and will be a revelation to all but crystal users.

Might I suggest that you take full page adverts. in all the wireless journals, out of kindness to listeners in who are using antiquated and greedy 3 v. .06 valves?

Yours faithfully,
W. T. Potter.

The "DEXTRAUDION" is a splendid Detector, also H.F. and L.F. amplifier, functions in all kinds of circuits and gives strength of reception equal to a bright emitter!

The price is 21/-.

40 Page Radio List with full particulars of the "DEXTRAUDION" and "XTRAUDION" Valves, also Complete Sets, Components and Material sent post free on receipt of 4d. in stamps.

ECONOMIC ELECTRIC LIMITED

Head Office:
10, FITZROY SQUARE,
LONDON, W.1.

Showrooms:
303, EUSTON RD.,
N.W.1.

Telephone:
MUSNUM
1055.

Quality RADIO COMPONENTS

Profusely illustrated twelve page CATALOGUE just out. If your dealer cannot give you one send us a card with his name and address to receive it direct FREE and POST FREE.

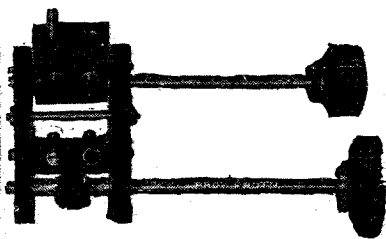

Prov. Protected.

CAM-VERNIER COIL HOLDER

Price 9/-, on base 1/- extra. With Reaction Reverse and Shorting Switch incorporated, 12/6. Postage 4d.

STANDARD COIL SOCKETS

Flush fitting
1/- each

Postage 2d.

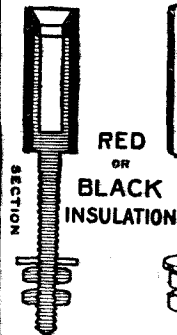
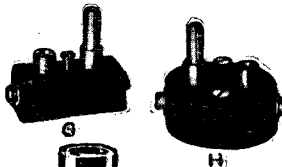

INSULATED VALVE SOCKETS

Set of 4, one red for plate, 1/- Postage 2d.

PANEL COIL HOLDER

(no base).

Back connections eliminating flex.
2 way 3/-,
3 way 5/-,
N.P. 1/- extra.

Post 3d.

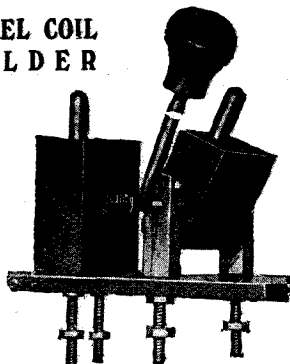

Drilling template with all.

If your dealer has not got them we send post free if you mention his name and address.

GOSWELL ENGINEERING CO., LTD.,

12a, PENTONVILLE RD., LONDON, N.1.
Liberal Trade Terms. Phone: North 3057.

broadcast receiver is to talk to an experimenter who already has a set installed. We hope that our advice will not be considered interested if we advise you to take in a good wireless periodical and to buy good authoritative books on wireless.

The Aerial

Having made, or bought, your set, the next thing to do is to fix up your wireless aerial, and this will only call for a little common sense and a little time in reading the aerial section of the two little books mentioned above.

"Range" Explained

A wireless transmitting station consists of special apparatus, which sets up electric currents in a length of wire slung up at as great a height as possible—usually between two masts. The currents in this aerial, as it is called, set up invisible wireless waves which travel in all directions. The distance these waves travel depends upon the power of the transmitting station. The waves may be received by the receiving station which consists of very much simpler apparatus, usually, and an aerial wire slung up, generally, between the house and a tree, or between two poles, or, in fact, in any other way. The receiving aerial for broadcasting and experimental work is usually about 100 feet long. When the receiving station is being operated the wireless waves from the transmitting station are caught by the aerial wire, producing electrical currents which operate the receiving gear and cause buzzing noises, speech or music, according to the nature of the transmissions from the transmitting station. These noises come from telephone receivers, or what is known as a loud-speaker, which is somewhat similar to a gramophone horn. The telephone receivers are somewhat similar to the telephone receiver ear-piece on the ordinary telephone. Any number of wireless receiving stations within a certain range of the transmitting station may be able to pick up the messages from that transmitting station.

What is Selectivity?

It may be asked whether, as so many wireless transmitting stations are working in the world, there is not a jumble. The reason why there is not a jumble is that the transmitting stations send out different kinds of waves, and at your receiver you pick out the particular kind that you want to receive.

Wireless waves are somewhat similar to the ripples produced on the surface of a pond when a stone is thrown into it. These ripples travel outwards in all directions, as do wireless waves. The wireless waves, however, are invisible. When one person speaks to another, the speech is communicated by waves in the air—sound waves. When a wireless transmitting station transmits, somewhat similar waves are set up, but they are not heard by an ordinary person in the ordinary way; they require a special receiving apparatus to make them audible.

Wavelengths

Different transmitting stations send out their messages with different kinds of waves. These waves differ from each other in their length; the length of a wave is the distance from the crest of one wave to the crest of the next wave. The receiving apparatus may be tuned—that is to say, adjusted—so as to pick up only the waves of a certain station. When different strings on a piano are struck different notes are sent out. Perhaps one note will be high and another low. The difference between these notes is that the sound waves in the case of one note differ from the sound waves produced in the case of the other note. The human ear can tell the difference between one and the other.

The Morse Code

In the same way, a transmitting station may be arranged to send its signals on one note or on another. The wireless receiver is also able to distinguish between the different wireless waves, and it is possible so to adjust the apparatus that only the desired waves will be received, the others not being made audible at all. By giving different stations different wave-lengths to work on, it is possible to be able to pick up at a receiving station waves from hundreds of different wireless stations.

Most ordinary wireless business messages are sent in the Morse code, which consists of short and long buzzes known as dots and dashes. These are arranged in a special manner to represent different letters of the alphabet. The broadcast listener will not need to learn the Morse code at all, but if he hears buzzing noises in his receiver these will probably be due to him hearing messages being sent in Morse code. The ordinary music and speech comes through just as if one were in the same room as the artist.

Easy to Begin

Wireless broadcasting is sent out from stations having a room in which the actual artistes appear. Unlike the case of the gramophone it is not possible to pick and choose one's items. There is a set programme each evening, just as in the case of a concert.

If you do not know much about wireless, do not be alarmed. The person taking up broadcasting needs no technical knowledge. The person who intends going in for experimenting can start straight away with only a small amount of technical knowledge which he can pick up from the two books mentioned above.



At a wireless outing. Wireless societies do a great deal of useful work. You should join.

Valve and Crystal

As regards the apparatus used in receiving, there are, in general, two classes of wireless receivers. We, first of all, have the crystal set and we also have valve sets. Some valve sets also use crystal detectors.

A crystal detector merely consists, in its simplest form, of a piece of mineral on which presses a light wire spring, generally known as a "cat's whisker." This crystal detector is fitted in a box which also contains a coil of wire called the inductance. Means are provided for tuning the crystal receiver to the particular broadcasting station which you desire to receive. On a certain adjustment of the set one station will be received, while with another adjust-

ment perhaps another station will come in. If you lived in London and your receiver was adjusted to receive 2LO, which is the call sign, or telepl one number, as it were, of the London broadcasting station, you would have to have a different adjustment if you took your set to Birmingham and wanted to receive that station, even if you worked on an exactly similar aerial.

A valve set is a set which uses a kind of electric lamp known as a valve. This valve has four prongs, which fit into a special valve holder, and it is necessary to provide two kinds of batteries to work a valve set. One battery is usually an accumulator which

can be recharged with electricity at suitable intervals; the other battery is called a high-tension battery and gives about 60 to 100 volts. These high-tension batteries will last several months and are then useless and a new one requires to be bought.

Books You Need

It is really impossible to enter into a detailed technical explanation of wireless in a magazine of this kind. The best thing you can do, unquestionably, is to buy the first two books of the Radio Press series called, respectively, *Wireless for All* (price 9d.) and *Simplified Wireless* (price 1s.). These two books, the second one of which is a sequel to the first, are written by Mr. John Scott-

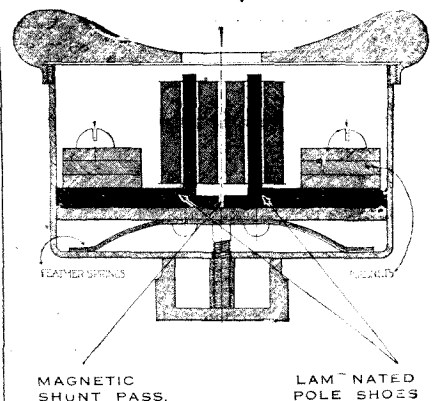
*Why***ULTRA**
REGISTERED TRADE MARK*Adjustable Phones
are still the best*

MAGNETIC SHUNT PASS.

LAMINATED POLE SHOES

Firstly:—

Because the Pole Shoes are laminated, thus minimising eddy currents.

Secondly:—

A Magnetic Shunt Pass is provided which eliminates distortion.

Thirdly:—

The Vernier Adjustment is perfect in its action.

THESE ADVANTAGES ARE EXCLUSIVE TO "ULTRA."

Ask your dealer for them

20/- per pair

Should you have any difficulty in obtaining same write direct to
Messrs. EDWARD E. ROSEN & CO.
158/160, City Road, London, E.C.
with the name of your Dealer.

Taggart, F.Inst.P., A.M.I.E.E., the Editor-in-Chief of Radio Press Limited, the publishing firm which produces THE WIRELESS CONSTRUCTOR, *Wireless Weekly* and *Modern Wireless*. These two little books have had an enormous sale and they presume not the slightest knowledge of electricity, so that the absolute novice can understand the rudiments of wireless.

About Valves

If you want to know something about valves and how they work you cannot do better than buy a copy of *Radio Valves and How to*

Use Them, by John Scott-Taggart, F.Inst.P., A.M.I.E.E.

If you are out to make your own wireless set you will do well to build one of those described in the pages of this magazine. Every set is personally guaranteed by the Editor and by the proprietors of THE WIRELESS CONSTRUCTOR. The actual sets may be inspected at our London Offices at Melbourne Buildings, Bush House, Strand, W.C.2. A subsidiary company of Radio Press Limited, called Radio Press Service Department Limited, will, on the payment of a small fee, test your set if you do not get

good results, and, if desired, will put the set right for you. You, consequently, can have absolute confidence when you start building a Radio Press set.

A Final Word

Our final advice is, worry your wireless friend. If you haven't a wireless friend, make one. Wireless experimenters are thoroughly good fellows, as a rule, and will gladly give you advice, but don't worry them over things you can read about in booklets costing only a few pence. It is not fair to them or to yourself.

A Useful Vice for Holding Panels

TO hold a panel of ebonite so that its edges may be cleaned up is rather beyond the scope of the engineer's vices usually found in the ordinary workshop, and the writer has purposely designed this vice to be described to overcome his own difficulty in that respect. A piece of wood, 3 ft. long, 1 ft. wide and 1

hole, through which passes a 2 in. No. 10 screw into the baseboard. The complete baseboard is shown

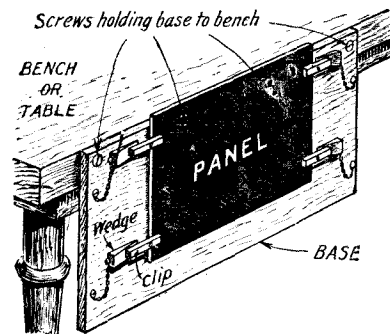

Fig. 1.—The vice in place.

in. thick is required for the baseboard, and may be purchased very cheaply at the local timber yard. Four smaller pieces of oak, 1/2 in. thick, 1 in. wide and 6 in. long, are also required. Four wedges should be purchased; those sold for preventing windows rattling are useful, as they also have a small length of chain attached to them as shown in Fig. 2, so that they can be affixed to the base and are not easily lost.

How to Fix the Base to the Bench

The base is secured by four good sized screws, 2 1/2 in. No. 10's, near its upper edge, to the edge of the bench or work table. The smaller pieces of oak are drilled with a 1/8 in.

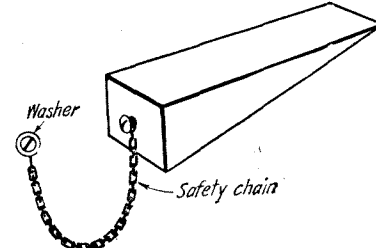

Fig. 2.—Wedge details.

in Fig. 1 holding a panel ready for edge cleaning. Fig. 3 shows how the clips should be cut and drilled. The edge marked A should be rounded off so that the thin end of the wedge may quite easily be pushed underneath.

How to Use the Vice

The method of using the vice is as follows:—The panel is temporarily laid against the baseboard and a pencil mark made round the panel.

Four gimlet holes are made in suitable positions (see Fig. 1) and the clips (Fig. 3) are screwed to the baseboard. These should not be screwed down tight, but sufficient room left so that the panel slips in underneath. The panel is placed in position and the wedges pushed home tightly. It will be found that the panel is held extremely tight

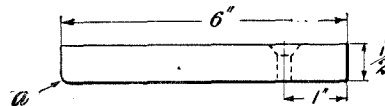

Fig. 3.—The clips which hold the panel in position.

and will not slip about when pressure is applied to the edge.

The little safety chains should be secured to the edge of the baseboard by means of 1/2 in. No. 4 screws.

Another Use for the Vice

The same idea may be applied to the top of the bench for cutting ebonite or drilling panels. The wedges and clips can at the same time hold the drilling template in correct position. If polished material is used little pieces of felt should be glued to the faces of the clips to prevent scratching the surface.

A Famous "Fan"



Jackie Coogan is just as keen on wireless as most young men. Here he is seen sending a wireless telegram from the "Leviathan."

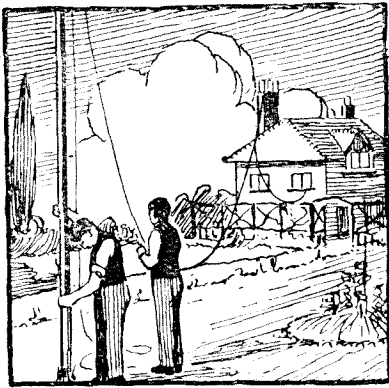

Some Common Faults in Beginners' Sets

By G. P. KENDALL, B.Sc.

No wireless expert has greater experience in handling beginners' sets than Mr. G. P. Kendall, B.Sc., the well-known chief of the Radio Press Information Department.

I DO not wish the title of this article to convey the impression that faults are common in sets built by beginners, since this is far from being the case, and I hope I shall not produce a feeling of apprehension in the mind of anyone who may be considering the building of his first wireless set. As a matter of fact, a very wide experience leads me to believe that faults in the working of a newly finished receiver are as common among the sets made by experienced constructors as among those produced by relative novices. True, the novice

is apt to make little slips that an experienced man would have avoided, but on the other hand the former generally follows out the design to which he is working with great accuracy, indulging in no departures from the specification, and therefore his chances of success are usually considerably higher than those of the man who feels himself confident to make considerable modifications in every small layout.

Follow the Design.

So long as the beginner will take a good design and follow it out

accurately, he need have no fear of anything except quite trifling troubles in the finished receiver. The chances of such troubles, it should be emphasised, are remote, and I think it as well to state at the commencement of the article, that it will be devoted to the troubles of sets properly designed which fail to give expected results.

Now, when a new set has been made, and fails to give the expected results, there are three principal ways in which it may behave. In the first place, there may be an entire absence of signals, which is, curiously enough, the

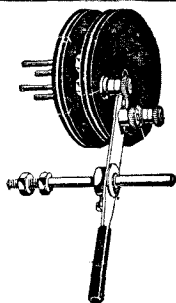

Tapped Anode Inductance. Designed as part of our Registered Reactance System, is a most convenient Tuned Anode unit for 180-3,000 metres. It is perfectly made and calibrated, while its neat dead-end switch brings in the sections one at a time. 25/-.

L.F. Intervalve Transformers. The Power-Plus will give tip-top amplification and thorough satisfaction. All usual and reasonable tests are made of every transformer, and we guarantee it for ordinary voltages on any "R" Type or D.E. valve, 14/6. With nickel fittings 15/6. The H.D. A very fine transformer of slightly different form. Fully guaranteed for use up to 130 volts 17/6 R.I. Transformers 25/- Telephone Transformers 13/6



THE NEW RADIAX REACTION UNIT IS INSTANTLY FITTED TO ANY PANEL

Make Your H.F. Valves Efficient.
The New Radiax Reaction Unit (Regd.) achieves a remarkable efficiency; with perfect control can be used on any transformer, but in conjunction with the RADIAX H.F. Transformers or Tuned Anode Coils, it makes an average set into a "Super"—without the super's difficulties of control. Probably no other method will enable coupling so close to oscillation point, without distortion or re-radiation. Height is instantly adjustable. With one-hole fixing, perfect finish and guaranteed uniformity, suitable for 500-1,600 metres, the price is 6/9. Extra coils instantly interchangeable, 100-300 3/3, 1,600-4,000 3/9.

The New H.F. Transformers and Tuned Anode Coils are the result of two years' concentrated experiment and experience on H.F. Valve Couplings. The proportions of primary and secondary provide a definite and effective potential Step-up, which is often talked of but seldom obtained. Tuned with a .0025 Variable Condenser the marked wavelength range is guaranteed. Post Office quality ebonite with all surfaces machined prevents leakage losses. For best reaction results use Anode Coils above 1,600 metres. H.F. Transformers 95-180, 3/6; 170-330, 3/6; 300-500, 3/6; 500-900, 4/3; 900-1,600, 4/9; 1,500-2,600, 5/6; 2,600-4,000, 6/6. **Tuned Anode Inductances same range and prices as Transformers.** For two or more stages H.F. use Radiax Transformers on first stage up to 500 metres, Tuned Anode Coil over 500. For second and further stages **Radiax Semi-Periodic Anode Coil** untuned. This gives a perfect system which does amplify and doesn't self-oscillate. Prices 9d. each extra up to 900 metres. 1/6 each extra over 900 metres.

LISTS AND CATALOGUES.—Please send stamp for sectional lists and descriptions of (1) Reactance and H.F. Couplings; (2) Radiax Receiving Sets. Complete or in parts, or 3d. stamps for full Catalogue including Accessories and Components.

RADIAX Duplex Basket Coils

Far more efficient than honeycomb or any other type of coil. Exceedingly strong and rigid, mounted on standard ebonite plugs.

No.	Price.	Wave-length.	No.	Price.	Wave-length.
25	1/6	350	100	2/9	1350
35	1/9	450	150	3/-	2000
50	2/-	650	200	3/9	2600
75	2/3	900	250	4/6	3200
			300	5/6	4000

Complete set of 9 for 25/-.

YOUR DEALER CAN SUPPLY ALL RADIAX COMPONENTS.

CONDENSERS (Fixed).—0.0002, .0003, .0005 or .001, 1/- each. With cartridge type grid leak 2/6. **CONDENSERS** (Mansbridge).—For H.T. Batteries, etc., .5 mfd., 4/- 1.0 mfd., 4/6, 2.0 mfd., 5/6. **ACCUMULATORS.**—High grade, our name on each one guarantees reliability. 2-volt. 4-volt. 6-volt. 40 amp. .. 11/6 19/6 27/9 60 amp. .. 15/- 25/- 36/6

IF YOU WANT TO BUILD YOUR OWN SET GET OUR LISTS AND ADOPT A RADIAX DESIGN.

RADIAX, Ltd.

44, Radio House, Percy Street, Tottenham Court Rd., London, W.1. 3 min. Tottenham Ct. Rd. & Coodge St. Tube Stations

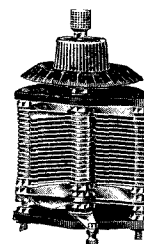

Vernier Condenser. Both knobs deeply fluted, ensuring easy control. Vernier indicator shows position and makes the finest tuning simple. Their high overall efficiency enables hitherto impossible stations to be tuned in readily.

Capacity	Best Quality. With Vernier.	Best Quality. Without Vernier.	Cheaper Quality. Without Vernier.
	.001 ..	12/-	8/6
.0006 ..	10/-	7/-	5/9
.0003 ..	10/-	6/-	5/-

Radiostat. A universal filament resistance, infinitely variable. Suitable for ordinary or D.E. valves. Price 2/9.

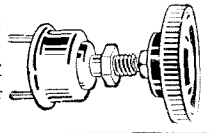

easiest kind of trouble to deal with. Secondly, the set may give weak signals with an absence of distant stations, while in the third case it may give fairly moderate signals but to an accompaniment of howling or crackling noises.

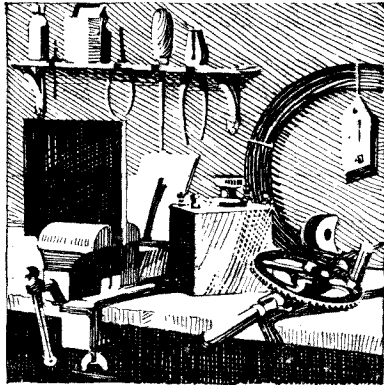

A First Step.

The first step in any one of these cases is to determine whether the fault is actually in the receiver itself; in the accessories; or in the aerial or earth connection. The accessories may consist of the telephones or loud speaker, the high and low tension batteries, and

the valves. The voltage of the high and low tension batteries can be measured when they are actually giving current to the set, if you possess a suitable voltmeter, but this is not the rule and by far the best method of testing is to substitute other batteries for them. Similarly, the valves can only be tested by substitution, and the same may be said of the telephones. If no other accessories are available for testing, it is usually possible to try one's own upon somebody else's set, which method is almost as good.

Aerial and Earth.

The only real test of an aerial and earth, again, is that obtained by trying upon them a receiver which is known to be in perfect working order. Incidentally, a word of warning should be issued here to those who come to the conclusion that any given set is not working properly simply because the owner is at first unable to pick up the more distant stations. The operating of any set is undoubtedly an art. It can be quickly picked up but nevertheless must be learned. Therefore, do not expect to pick up all the B.B.C. stations with your first single valve set within half an hour.

As soon as the necessary preliminary tests have been completed, and they have proved that the trouble is actually in the receiver itself, it is then necessary to come to some conclusion as to the type of fault which is likely to be present. If the trouble is an entire



absence of signals, the most likely cause is—a mistake in wiring; an imperfectly soldered joint; or a defective component. Weak signals, on the other hand, may also mean defective component, such as a grid leak of too small a value, a condenser with leaky insulation, or an ebonite panel of poor quality, but all these troubles are ones that the beginner

The resistance and capacity in this most vital part of your receiver is determined by the spacing of the valve-legs. The inefficient valve-holder increases the capacity and lowers the resistance by reducing the distance between the valve sockets. The H.T.C. Valve Holder designs contacts to be widely spaced. Resistance and capacity is therefore kept down to that of the valve. *Especially useful for plug-in H.F. Transformers.*

HIGH AUTHORITY ON GOOD VALVE HOLDER DESIGN

Mr. John Scott-Taggart, F Inst.P., A.M.I.E.E., writes in the September issue of MODERN WIRELESS on "Multi-Stage High-Frequency Amplification."

"Much can be done with the ordinary type of valve, provided a suitable valve holder is used. Quite apart from other merits, the widely-spaced contacts on certain types of special valve holders are particularly suitable for high-frequency work. The ordinary arrangement where the socket pins are very close together, the nuts and washers being frequently only a matter of 1/16th inch apart, are entirely unsuitable for high-frequency, OR, IN FACT, FOR ANY OTHER WORK."

Type A (above panel), Template Supplied .. 1/9
Type C (below panel), Template Supplied .. 1/6

British and Foreign Patents Applied For.

See you get H.T.C. Products from your dealer. If you would be certain of getting improved reception insist upon them. Remember, if he cannot supply we are pleased to send them direct to you.

The trade should bear in mind that H.T.C. Products are scientifically designed. Every product contains definite improvements which give better reception. Ask your local factor or write direct.

THE PRODUCT OF MANY EXPERIMENTS.

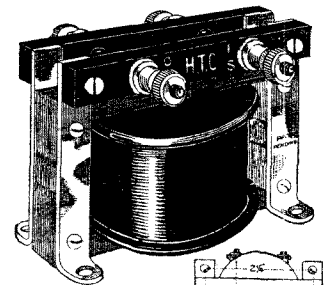

LENGTH = 2 3/4"
HEIGHT = 2 1/4"

You may buy H.T.C. Transformers with confidence, although the price is low. There is no reason why you should incur greater expense with the hope of securing better results. **Extraordinary care expended upon their design, and relentless inspection during their construction and of the materials used, preclude any possibility of manufacturing fault.** The design of the H.T.C. is such that all conditions are favourable and it operates efficiently in all circuits. They are designed to give power combined with purity of reproduction. Price **15/-** with purity of reproduction.

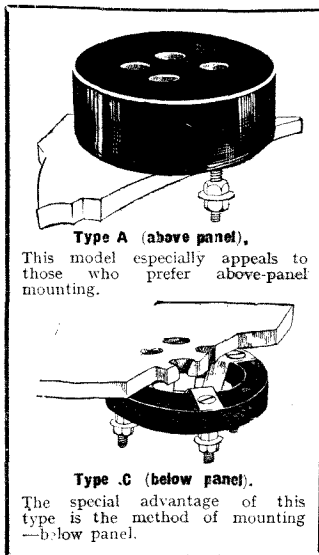

Type A (above panel).

This model especially appeals to those who prefer above-panel mounting.

Type C (below panel).

The special advantage of this type is the method of mounting—below panel.

If your local dealer cannot supply write direct to:
H.T.C. ELECTRICAL CO., LTD.

2 & 2a, BOUNDARIES ROAD, BALHAM, S.W.12.

Trade Enquiries Invited.

TELEPHONE: Battersea 374

cannot very well deal with for himself, and no doubt his best course is to take the set along to the Radio Press Service Department at No. 2, Melbourne Place, Strand, W.C.2, and leave the matter in more experienced hands than his own.

Noises may again mean a defective component, such as a grid leak; anode resistance, partially broken down intervalve transformer and so on, but by far the commonest fault of all is a defective high-tension battery, a leaky panel or a film of some conductive material such as is used in soldering upon various parts of the panel and components.

Obscure Troubles.

We will now proceed to consider some of the most common faults to which the beginner should give his attention when he first realises that his set is defective. If, after paying attention to the points which we are now going to discuss, it is still giving trouble, he will be well advised not to worry himself with the more obscure faults, but to take advantage of the Department provided by the Radio Press to deal with such cases.

Bad Ebonite.

A fault which is more likely to be found in sets built by novices than in those of the more experienced constructor is that of poor insulation upon ebonite panels, since the novice may be, in most cases, prompted to buy ebonite of some unknown origin in which there may be a high percentage of foreign matter, such as ground-up slate, which is incorporated simply to make the ebonite heavier, and without regard for its insulating properties. The obvious precaution is to buy ebonite only from some firm which we know, or better still to obtain one of the brands which are marked with the manufacturer's name. Leakage may also occur from an ebonite panel which is composed of sound material, simply because the constructor has not seen a word of advice that much ebonite is turned out from the works with a shiny surface whose insulating properties

are not nearly so good as those of the bulk of the material. This is the result of a certain process of manufacture, and a definite rule should be made that all one has to do is to rub off the surface skin of every panel, with fine emery paper. The result, it should be noted, is a very fine matt finish, and a safeguard against leakage. The only case when this need not be done is when ebonite is guaranteed free from leakage, and can then be used in its original form.

The main results of leaky ebonite are weak signals, flat tuning, and crackling noises.

Wiring Mistakes.

It is not often that one finds on test that a mistake has been made in wiring, when the set has been

Since such risks are unpleasant, it is really well to adopt considerable precautions in checking the wiring when the set has been completed, and before it is tried. The same procedure should be followed when it is realised that a set does not work, probably because it is a wiring mistake that has been made, by checking off each wire with the wiring diagram or blue print.

A Good Plan.

Lay out the blue print beside the panel, when the latter has been placed on a table with the underside turned upwards and proceed to compare each wire with the corresponding line upon the blue print, and when you have satisfied your-

self that the wiring agrees in every detail with the copy of the blue print, trace or otherwise endorse that line upon the diagram, or separate it by going over it with a coloured ink. In this way you can proceed until every line upon the blue print has been marked out carefully and you can feel fairly positive that you have compared the whole of the wiring. There is just a possibility that there may be a wire too many upon the

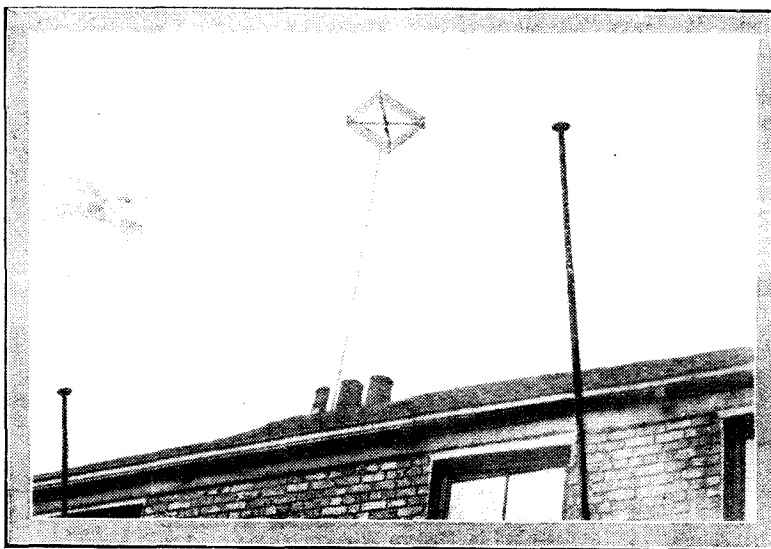

In some districts one may see "frame" aerials hoisted this way. It is doubtful whether there are any advantages.

made up from one of the Radio Press designs, which always incorporate a particularly full and clear wiring diagram. However, mistakes do occasionally occur and it may be of use to deal with some of the methods of testing such faults.

By wiring faults I mean the connecting together of two parts which should not have been so connected or the omission of some connection which the wiring diagram indicates should have been included. When a mistake of the former character occurs, one is likely, if the result is merely an absence of signals, to find two points which will either short circuit the batteries, or have the effect of putting the high tension supply across the filaments of the valves connected together.

set, however, in this method of checking. It could have been revealed in the wiring process, nevertheless, by adopting the reverse procedure to that we have just detailed. When laying out the wiring, as each wire is put into place, the corresponding line upon another blue print should be crossed out, and in this way care can be taken to insert no wires for which a line cannot be crossed out upon the diagram. Possibilities of error are therefore practically eliminated.

Bad Soldering.

Here we come to one of the great pitfalls of the novice, namely, the soldering of joints. Soldering is always to be recommended, since if it is properly done it makes a really sound and per-

manent job of the wiring, but it cannot be denied that it is one of the greatest difficulties to the beginner. No one should undertake the wiring of a set without some preliminary practice with the soldering appliances and the novice should make himself fairly proficient in the making of simple joints before he undertakes the work. It must be remembered that it is quite possible to cause one wire to adhere to another by solder without actually effecting a sound electrical connection. I have seen very many cases of sets which only give the poorest of signals and are much troubled with noises, upon which half-a-dozen joints existed which looked fairly sound, but which gave way upon being given a sharp pull with pliers.

A Peculiar Fault.

Upon investigation it was then found that although the parts had been adhering, there was a film of flux between them, which effectively prevented the proper flow of current to the correct point. The remedies are to thoroughly clean all surfaces which are to be soldered together, to tin them properly before attempting

to join them, and to use a really hot and clean soldering iron.

Remember that although high resistance joints, such as are produced by poor soldering, may not completely prevent a set from working, yet nevertheless a series of such joints may produce bad effects such as flat tuning, refusal to oscillate, distortion in resistance capacity-coupled low-frequency amplifiers, and so on.

Defective Components.

The wireless market at the present time is flooded with component parts of nameless origin, and there is a real risk to beginner and experienced constructor alike, of purchasing components which are practically valueless as wireless apparatus, unless some rule is made to purchase only from reliable firms, such as those who advertise in pages of this journal.

Shoddy Condensers.

One of the commonest causes of trouble, for example, are the cheap and shoddy-looking fixed condensers which can be bought from road, upwards, from certain wireless dealers. I have known innumerable cases of trouble directly traceable

to these condensers, and in some which I have opened I have found that the case contained nothing but a mass of wax, and no plates or dielectric whatever. Then, grid leaks are a possible source of trouble, and here again the precaution should be adopted of buying only those of well-known manufacturers. A grid leak of incorrect resistance, will give weak signals, uncontrollable reaction, tendency to howl, and also distortion. A badly made leak may also give great trouble by the production of crackling and rustling noises.

Take No Risks.

There is not much that the novice can do when he comes to the conclusion that some of his components are open to suspicion, since the testing of the articles requires a certain amount of experience and elaborate apparatus. For the cheaper parts the usual substitution can be applied and this is advised. Such things as low-frequency transformers, on the other hand, are too expensive to be treated in this way, and here again the service of our Department should be sought.

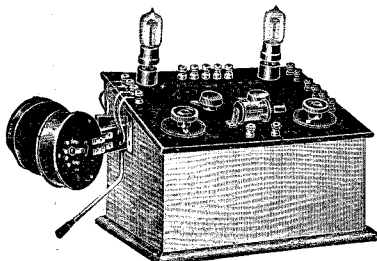

Construct the S.T. 100 for £7-4-2. (Envelope No. 1.)

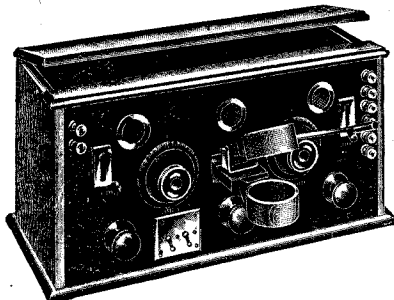

CONSTRUCT THE ALL CONCERT de LUXE for £9-9-0. (Envelope No. 4.)

RADIO PRESS ENVELOPES.

	Post free.
No. 1. S.T. 100	1/8
No. 2. 4-Valve Family	2/9
No. 3. Simplicity 3	2/9
No. 4. All Concert-de-Luxe	2/9
R.P. Hot Pad Transfers	8d.

CONSTRUCT YOUR OWN SET

An S.T. 34 with Resistance Coupled Note Magnifier as described in Modern Wireless (October) issue.

1 Sloping Cabinet	18 0
1 Ebonite Panel, Drilled and Engraved	15-0
14 by 10 by 1/2	9-6
1 2-Way Coil Holder	1-6
1 Coil Plug	10-6
3 Lissenstat Minor	12-6
1 Variable Condenser .0005 and Vernier	11-6
1 " .0003 and Vernier	4-6
1 H.T.C. Valve Sockets "C"	5-6
1 Dubilier 100,000 ohm Resistance	5-0
2 " 2 megohm Leak	3-6
1 Mansbridge Condenser .25 mfd	6-0
2 Dubilier " .002 mfd	2-6
1 " " .0003 mfd	2-6
1 " " .0001 mfd	9
6 Yards No. 16 square section T.C. wire	2-8
14 Terminals (Lacquered) complete	

£5-11-5

No. 16 D.C.C. wire for P. W. Harris Crystal Set (September issue) 3/- per lb. post free.

Send stamp for Illustrated List and set of leaflets dealing with S.T. 100, 4-V. Family, Simplicity 3, All-Concert-de-Luxe, Transatlantic V., Puriflex, Omni, etc., etc.

Carriage and Packing free on retail orders value £2 or over.

BURNE-JONES & Co., Ltd.,
Magnum House, 288, Borough High Street,
LONDON, S.E.1.
PHONE HOP 6257.

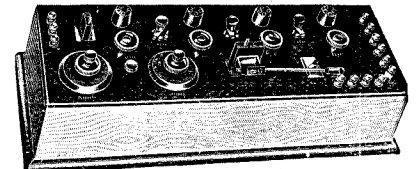

CONSTRUCT THE 4-VALVE FAMILY for £9-4-5 (Envelope No. 2.)

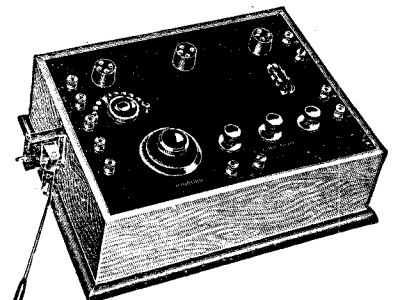

CONSTRUCT THE SIMPLICITY 3-VALVE for £4-11-8 (Envelope No. 3.)

MAGNUM COIL HOLDERS.

As used in Simplicity 3, All-Concert de Luxe, Transatlantic 5, Puriflex, etc. etc. 2-way 9/6, 3-way 12/- Post 6d. When ordering Please state name of set.

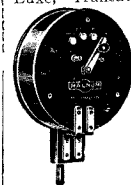

MAGNUM TAPPED COIL.

No. 1 12/6, No. 2 15/- No. 1 equivalent to Nos. 25, 35, 50, 75 Plug-in coils. No. 2 equivalent to Nos. 100, 150, 200, 250 Plug-in coils.

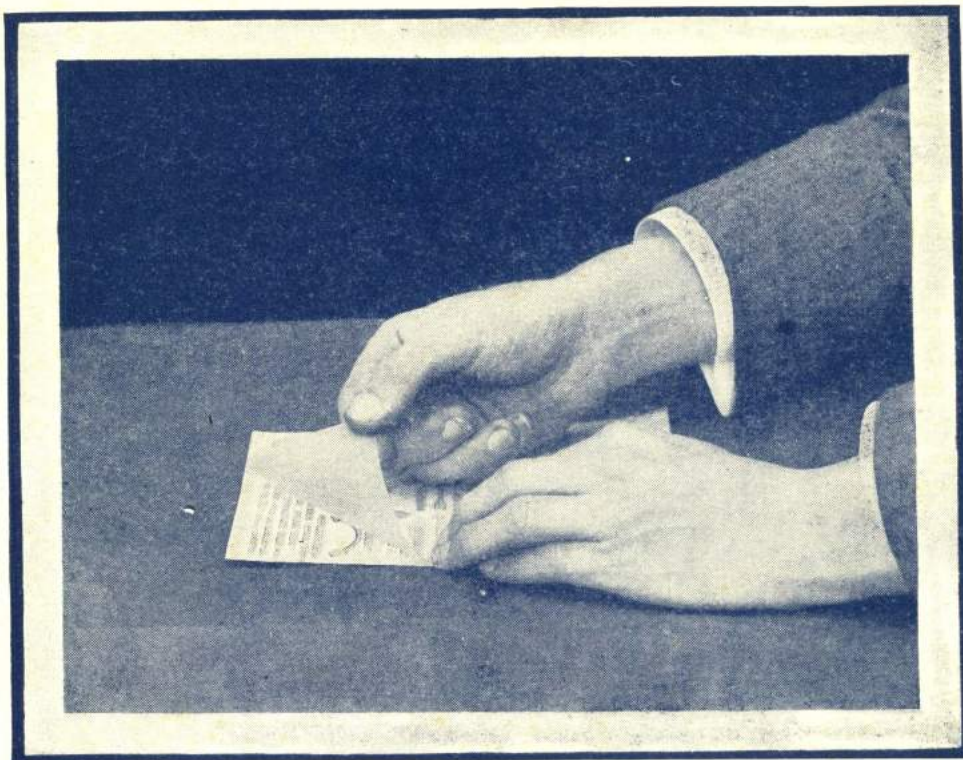

—as simple as a child's transfer
The new method of marking the panel.

THE new method of marking the panel—in preference to engraving—is by using Radio Press Panel Transfers. A hot cloth and a pair of scissors are the only "tools" required. This is how the job is done: remove the stiff protective covering from the face of the transfer (as in the photo), cut the label required, and lay it face downward upon the panel in the exact position it should occupy. Heat a cloth pad and press the transfer in firm contact with the panel. It will immediately adhere, and the paper backing can be removed. A few minutes will see the whole of the panel clearly marked quite as neatly as engraving at a fraction of its cost. The Radio Press Envelope includes every possible title it is possible to think of, together with many duplicates. Get one to-day from your Bookseller and complete your existing Receiver.

Get a Set
To-day!

From
all Booksellers

Radio Press Ltd.
Bush House, Strand, W.C.2

6^D
PER SET.

ASK FOR: "RADIO PRESS
Panel Transfers"

Shall I wrap it up, Sir?

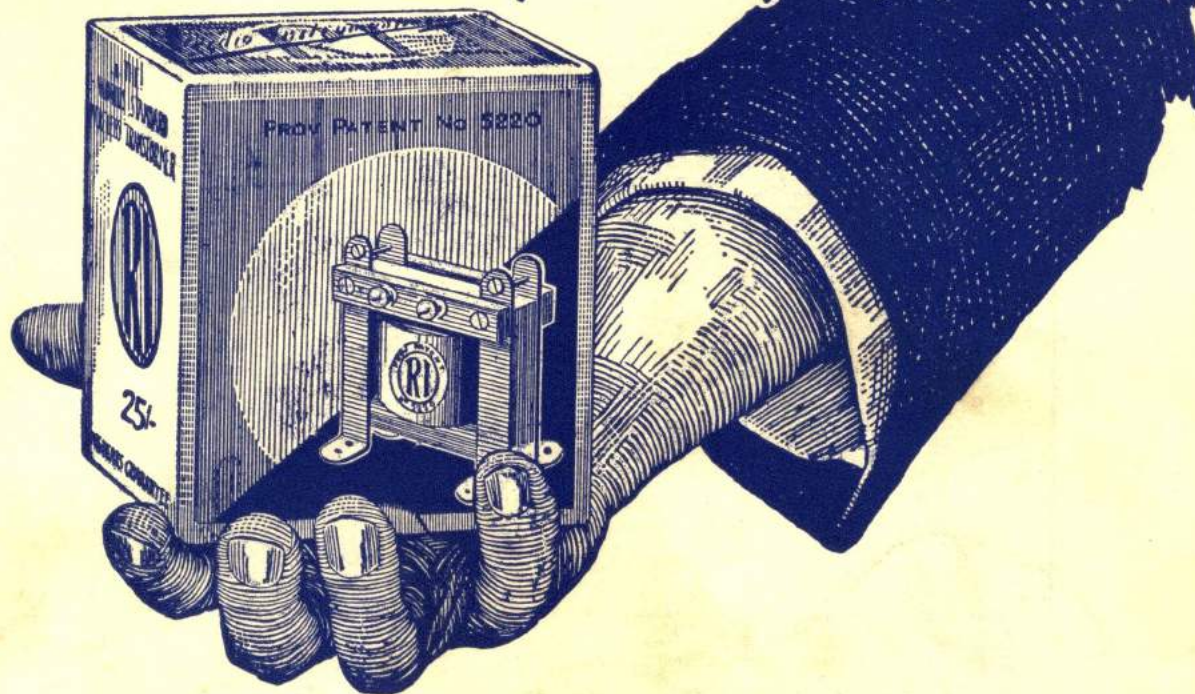

THE MASTER TRANSFORMER.

YES—18 micro-microfarads, the lowest self-capacity of any transformer in general use, it eliminates the chief cause of distortion and enables a greater degree of amplification to be obtained at the higher frequencies up to the useful range of audibility.

The internal construction is so different, the primary and secondary windings are each split up into six sections, the primary being placed on the outside of the secondary. Consider the advantage this method must have over the usual system, where the coil is wound higgledy-piggledy over the whole core. The National Physical Laboratory have tested the New R.I., the results have been published in the Press, and all particulars are available for your inspection.

Buy The Transformer designed and built in every detail to approach the ideal.

- 1.—Correct inductive values of primary and secondary windings.
- 2.—Minimum hysteresis, capacity, and leakage losses.
- 3.—Low self-capacity between and across windings.
- 4.—Efficient iron circuit.
- 5.—High insulation between individual windings and core.
- 6.—Maximum mechanical strength and freedom from breakdown.

A year's guarantee, and one R.I. Transformer Booklet with distortionless circuit diagrams supplied with each instrument.

Telephone: Regent 6214-5-6

Telegrams: "Instradio London"

Radio Instruments Ltd.
12 Hyde Street, Oxford Street W.1.